

# V&V AGRORICAMBI



## TRATTAMENTO DEL FIENO

*Taglio - raccolta - imballaggio  
trasporto - uso dei foraggi*



# CATALOGO 2020

VIA DELL'ARTIGIANATO, 50 - 36050 BOLZANO VICENTINO (VI)  
Tel. 0444351435 Fax 0444354401  
vvagroricambi@gmail.com - www.vvagroricambi.com

## Indice ricambi per macchine trattamento fieno

pagina	125	MOTOFALCIATRICE BCS 622
pagina	126	MOTOFALCIATRICE BCS 622
pagina	127	MOTOFALCIATRICE BCS 622 (BARRA TIPO NUOVO)
pagina	128	MINIFALCIATRICI BCS SERIE 600-700
pagina	129	MINIFALCIATRICE BCS SERIE "EUROPA"
pagina	130	BARRE FALCIANTI BILAMA BCS DUPLEX E DUPLEX "GOLD"
pagina	131	MOTOFALCIATRICE BERTOLINI-MINIFALCIATRICE BERTOLINI "PRATOLINA"
pagina	132	MOTOFALCIATRICI OLYMPIA-FIGARO-LAVERDA - BILAMA BUSATIS - SISTEMA DI TAGLIO "ESM"
pagina	133	BARRA FALCIANTE GASPARDO (MONOLAMA TIPO VECCHIO) - BARRA FALCIANTE LAVERDA
pagina	134	BARRA FALCIANTE MONOLAMA GRIBALDI & SALVIA (GS)
pagina	135	BILAMA G&S SUPERIOR SERIE "72" - BILAMA G&S SUPERIOR SERIE "394"
pagina	136	BILAMA GASPARDO "FB 925"
pagina	137	BILAMA GASPARDO "FB 940" - BILAMA GASPARDO "F B R" (VITI)
pagina	138	BILAME GASPARDO PARTICOLARI ORIGINALI <b>Novità</b>
pagina	139	MINIFALCIATRICI SEP - MINIFALCIATRICI DIVERSE - LAME LVB
pagina	140	FALCIATRICI ROTATIVE (NOTTOLINI, PIATTELLI, I PORTA-COLTELLO)
pagina	141	FALCIATRICI ROTATIVE (PIASTRE PORTA-COLTELLO)
pagina	142	FALCIATRICI ROTATIVE (PIASTRE PORTA-COLTELLO)
pagina	143	FALCIATRICI ROTATIVE (DISCHI FOLLI)
pagina	144	FALCIATRICI ROTATIVE (DISCHI FOLLI - DISCHI TRAINO - TAMBURI - TELI - COMPONENTI VARI)
pagina	145	COLTELLI PER FALCIATRICI ROTATIVE (1)
pagina	146	COLTELLI PER FALCIATRICI ROTATIVE (2)
pagine da	147	DENTI A MOLLA PER MACCHINE TRATTAMENTO DEL FIENO (girelli - giroandanatori - rastrelliere - autocaricanti - presse - rotopresse - ranghinatori a pettine, a nastro, stellari - voltafieno - ruote per girelli)
a	162	
pagina	163	ATTACCHI FERMADENTI - ARTICOLI VARI PER MACCHINE FIENAGIONE
pagina	164	DENTI E SEZIONI LAMA PER MIETITREBBIE
pagina	165	DENTI E SEZIONI LAMA PER MIETITREBBIE, PER CESTE FALCIANTI - COLTELLI TRINCIAPAGLIA

# MOTOFALCIATRICE BCS 622



Cod.	Descrizione prodotto	Immagine	Cod.	Descrizione prodotto	Immagine
20000/ D 20000/ S	ANDANA DESTRA 20655 - ANDANA SINISTRA 20657		20270	MANETTINO GAS 2538 (FIL. M8 FEMM.)	
20020	ANELLO DIST. BIELLA 2394		20275	MANOVELLA OSCILLANTE 52302815	
20030	ASTA CONSUMO 17 SEZIONI 20703		20276	SPINA CILINDRICA PER MANOVELLA	
20040	ASTA CONSUMO 19 SEZIONI 2709		20280	MOLLA BIELLA FERRO 2430	
20050	ASTA CONSUMO 21 SEZIONI		20290	MOLLA CONICA BRACCIO 20137	
20060	ASTA FORATA 17 SEZIONI 20708		20300	PIASTRINA DENTE FITTO 2355	
20070	ASTA FORATA 19 SEZIONI 2465		20310	PIASTRINA DENTE SEMIFITTO 2477	
20080	ASTA FORATA 25 SEZIONI		20320	PIASTRINA SCARPA DESTRA 2847	
20090	ATTACCO LAMA 20494		20330	PIASTRINA SCARPA SINISTRA 2848	
20100	BIELLETTA PLASTICA 20680			20340	PREMILAMA 1 FORO 2823
20110	BLOCCHETTO FILETTATO 2512		20350	PREMILAMA A CAVALLOTTO 2824	
20120	DENTE FITTO 27622		20360	PREMILAMA LATERALE DESTRO 2825	
20140	DENTE SEMIFITTO 27624		20370	PREMILAMA LATERALE SINISTRO 2829	
20160	DENTE SEMIFITTO SPECIALE		20375	PREMILAMA REGISTRABILE 1609	
20180	GAMBO BIELLA FERRO 2707 ORIGIN.		20380	PREMISTRISCIA 2828	
20190	GOMMINO BIELLA FERRO 2581		20390	BLOCCHETTO PORTARULLINI COMPLETO 52202885	 Solo rullini 
20200	GOMMINO BIELLA PLASTICA 20684		20400	COPPIA SEMIGUSCI IN BRONZO 2872+2905	
20210	PREMILAMA POSTERIORE 20685		20410	SEZIONE RIGATA 2466	
20220	LAMA RIGATA 15 SEZIONI 20714		20415	SEZIONE 2466 CON RIG. INTERA	
20230	LAMA RIGATA 17 SEZIONI 20716		20416	SEZIONE 2466 (NON FINISTRATA)	
20240	LAMA RIGATA 19 SEZIONI 20688		20420	SFERA CON CONO SEMIGUSCI 2874	
20250	LAMA RIGATA 21 SEZIONI 20718				
20260	LASTRINA DI TENUTA 2856				

**SU RICHIESTA  
FORNIAMO  
PARTICOLARI  
ORIGINALI**



segue →

## MOTOFALCIATRICE BCS 622

Cod.	Descrizione prodotto	Immagini	Cod.	Descrizione prodotto	Immagini
20430	SPINOTTO BIELLA 2514		20475	SCATOLA 2 BRACCI BCS 590.20827.5	
20440	SUOLA DESTRA 2897 BCS 622 - SUOLA SINISTRA 2898 BCS 622		20480	VITE PER DENTI 10x25 TE (106) - 10x30 TE (107) BCS 622	
20460	TESTA BIELLA FERRO 2817 BCS 622		20490	SILENTBLOC 14x30x25x28 BCS 622	
20975	FILO E GUAINA FRENO DESTRO BCS 20102		20977	FILO E GUAINA FRIZIONE T.V. BCS 20169	
20976	FILO E GUAINA FRENO SINISTRO BCS 20103		20978	FILO E GUAINA FRIZIONE T.N. BCS 20331	
			20979	FILO E GUAINA FRIZIONE GAS BCS 1,2X970	

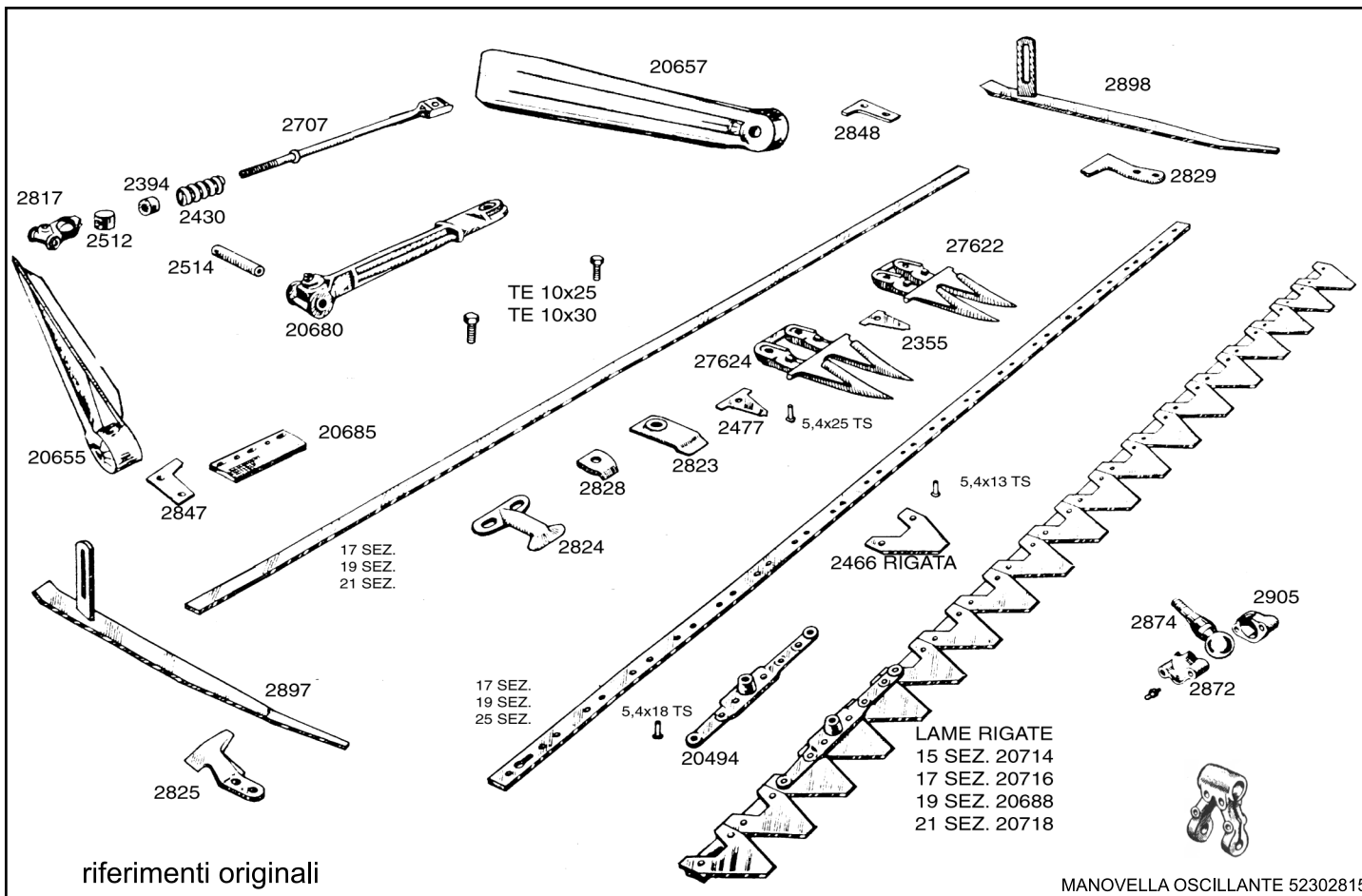

## SEDILI SEMPLICI PER MOTOFALCIATRICI

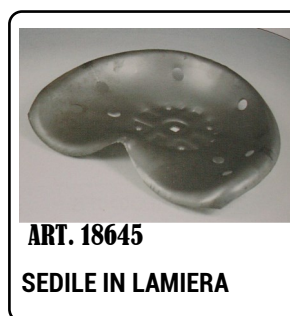

## MOTOFALCIATRICE BCS 622 (BARRA NUOVO TIPO)

Cod.	Descrizione prodotto	Immagini
22495	ASTA CONSUMO BCS T. NUOVO SEZ. QUADRATA	
22500	DENTE SINGOLO BCS-T.NUOVO	
22505	LAMA RIGATA ROVESCIA 17 SEZIONI BCS-T.NUOVO	
22510	LAMA RIGATA ROVESCIA 19 SEZIONI BCS-T.NUOVO	
22511	LAMA RIGATA ROVESCIA 21 SEZIONI BCS-T.NUOVO	
22515	PIASTRA DENTE SEMIFITTO BCS-T.NUOVO 27604	
22516	PIASTRA DENTE FITTO BCS-T.NUOVO	
22520	PIASTRINA SCARPA BCS-T.NUOVO	
22525	PREMILAMA 6022 BCS-T.NUOVO A CAVALLOTTO	
22530	PREMILAMA 6033 BCS-T.NUOVO DIRITTO	
22535	PREMISTRISCIA 6103 BCS-T.NUOVO	
22540	SEZIONE RIGATA mm 75 SVAS. SOTTO BCS-T.NUOVO 27785	



FILETTO GAMBO	INGRASSATORI "HYDRAULIC"
6x1	
6x1 LUNGO	
8x1 8x1,25	
10x1 10x1,5	
A 45° A 90°	

TESTINA EXCELLENT	
TESTINA A 90°	
TESTINA 4 GRIFFE	

POMPE GRASSO MANUALI (GRASSO SFUSO O CARTUCCIA)



## FUNI E GUAINE



Cod. 09150	FUNE IN ACCIAIO Ø mm 1,62 - 19 FILI
Cod. 09160	FUNE IN ACCIAIO Ø mm 1,9 - 19 FILI
Cod. 09170	FUNE IN ACCIAIO Ø mm 2,5 - 19 FILI
Cod. 09180	FUNE IN ACCIAIO Ø mm 3 - 19 FILI
Cod. 09190	FUNE IN ACCIAIO Ø mm 4 - 19 FILI
Cod. 09260	GUAINA mm 3x6
Cod. 09270	GUAINA mm 3,5x7
Cod. 09280	GUAINA mm 4x8
Cod. 09290	GUAINA mm 5,5x10

# MINIFALCIATRICI BCS (SERIE 600-700)

Cod.	Descrizione prodotto	Immagini	Cod.	Descrizione prodotto	Immagini
22545	LAMA RIGATA BARRA CENTRALE BCS DUPLEX 19 SEZIONI		22600	SEZIONE RIG. 2" h-mm 80 -2 F. D2001 BCS S. 600-700	
22550	ASTA FORATA 23 SEZIONI 2" BCS S. 600-700		22604	SEZIONE RIG. 2" h-mm 80 -3 F. D2002 BCS S. 600-700	
22555	ASTA FORATA 27 SEZIONI 2" BCS S. 600-700		22605	SEZIONE RIG. 2" h-mm 80 -3 F. D2002 BCS S. 600-700 FORI SVASATI SOTTO	
22557	ASTA FORATA 31 SEZIONI 2" BCS S. 600-700		22606	SEZIONE RIGATA 3" BCS "600-700 SERIE 94" 4 FORI 59014	
22560	ATTACCO LAMA ANTIUSURA 48494 - 2" BCS S. 600-700		22610	SUPPORTO ATT. LAMA PER 2" 48905 BCS S. 600-700 (ANCHE "EUROPA", LUNGO)	
22565	ATTACCO LAMA PICCOLO 43538 BCS S. 600-700		22615	SUPPORTO ATT. LAMA PER 3" 43541 BCS S. 600-700	
22570	ATTACCO LAMA PICCOLO 59050674		22616	SUPPORTO ATT. LAMA PER 2" 48908 BCS S. 600-700	
22574	DENTE DOPPIO MULCHING BCS S. 600-700 - 20207				
22576	LAMA 11 SEZIONI 3" ATT. LATERALE BCS S. 600				
22580	LAMA 15 SEZIONI 3" ATTACCO CENTRALE BCS S. 600-700				
22582	LAMA 17 SEZIONI 3" ATTACCO CENTRALE BCS S. 600-700				
22585	LAMA 22 SEZIONI 2" ATTACCO CENTR. BCS S. 600-700				
22587	LAMA 27 SEZIONI 2" ATTACCO CENTR. BCS S. 600-700				
22590	PERNO CUSCINETTO 59043848 BCS S. 600-700 ORIGINALE				
22591	PERNO CUSCINETTO 48506 BCS S. 600-700 ORIGINALE				
22592	PERNO CUSCINETTO 43521 BCS S. 600-700				
22593	PERNO COMANDO LAMA CONICO FILETT. 46668 (SENZA BUSSOLA) BCS S. 600-700				
22594	BUSSOLA Ø 37 46667 PER PERNO COM. LAMA 46668 BCS S. 600-700				
22595	PREMILAMA MULCHING BCS S. 600-700 43559				
22596	VITE SENZA TESTA PER PREMIL. MULCHING M 16x12 43571				

## CANDELE PER MOTORI





Codice	Descrizione
07688	CANDELA fil. 14 TOSAERBA-MOTOSEGA CHAMPION CJ8 - T10
07691	CANDELA fil. 14 MOTOFALC. BENZINA BERU Z10 (147BU)
07694	CANDELA fil. 14 MOTOFALC. BENZINA BOSCH WR7B+
07697	CANDELA fil. 18 MOTOFALC. PETROLIO CHAMPION D21 - 502
07700	CANDELA fil. 18 MOTOFALC. PETROLIO NGK AB6



# MINIFALCIATRICI BCS SERIE "EUROPA"

Cod.	Descrizione prodotto	Immagini	Cod.	Descrizione prodotto	Immagini
22620	ATTACCO LAMA ALLUMINIO BCS-EUROPA 48536 (ORIGINALE)		22670	SEZIONE RIG. 2" h-mm 74 -2 F. mm 7 -50696 BCS-EUROPA	
22610	SUPPORTO ATT. LAMA PER 2" BCS-EUROPA 48905		22675	SEZIONE RIG. 2" h-mm 74 -3 F. mm 5,5 -59015 BCS-EUROPA	
22621	SUPPORTO ATT. LAMA CORTO PER 2" 48905-50616 BCS EUROPA		22677	SEZIONE RIG. SOPRA 2" 59015 BIS BCS-EUROPA (P86443)	
22622	KIT ATTACCO LAMA REGISTRABILE BCS-EUROPA 46663 PRIMO TIPO		22678	SEZIONE RIG. SOPRA 2" h-mm 90 BCS-EUROPA "LASER" (56358716)	
22625	BLOCCHETTO GUIDA BCS-EUROPA 51402		22679	SUPPORTO ATTACCO LAMA EUROPA "LASER"	
22630	DENTE DOPIO BCS-EUROPA 56550648 (ORIGINALE)				
22635	DENTE SINGOLO BCS-EUROPA (ORIGINALE)				
22637	LAMA 16 SEZIONI ATTACCO LATERALE BCS-EUROPA				
22638	LAMA 19 SEZIONI 2" BCS-EUROPA	(1)			
22640	LAMA 23 SEZIONI 2" BCS-EUROPA	(2)			
22645	LAMA 27 SEZIONI 2" BCS-EUROPA	(3)			
22647	LAMA 31 SEZIONI 2" BCS-EUROPA	(4)			
22648	LAMA 35 SEZIONI 2" BCS-EUROPA	(5)			
22649	LAMA 23 SEZIONI 2" LUNGHE BCS-EUROPA CON ATTACCO "LASER"				
22650	LAMA 23 SEZIONI 2" BCS-EUROPA T. N. SENZA ATTACCO	(1)			
22652	LAMA 27 SEZIONI 2" BCS-EUROPA T. N. SENZA ATTACCO	(2)			
22653	LAMA 31 SEZIONI 2" BCS-EUROPA T. N. SENZA ATTACCO	(3)			
22654	LAMA 23 SEZIONI 2" RIGATE SOPRA BCS-EUROPA	(4)			
22656	LAMA 27 SEZIONI 2" RIGATE SOPRA BCS-EUROPA				
22657	PERNO CUSCINETTO 48920 BCS-EUROPA (=48506 N.O.)		22685	LAMA 27 SEZ. 2" LUNGHE EUROPA LASER	
22658	PERNO CON FORO COMANDO LAMA 46719 BCS-EUROPA T. NUOVO		22686	LAMA 31 SEZ. 2" LUNGHE EUROPA LASER	
22659	BUSSOLA PER PERNO COM. LAMA 46718 BCS-EUROPA T. NUOVO		22687	LAMA 31 SEZ. 2" LUNGHE CON PLACCHETTE EUROPA LASER	
22660	PREMILAMA BARRA BCS-EUROPA 51400 CON VITE M8x35		22690	LAMA 31 SEZ. 2" CORTE BCS 700 ATT. LASER	
22636	PIASTRINA PULIZIA BCS-EUROPA		22680	ATTACCO LAMA BCS-EUROPA MOD. 15-EL CON VITI E DADI (ORIGINALE) 59258753	
			22681	VITE REG. BCS 58058662+DADO 58058661 PER ATTACCO LAMA 59258753 (ZN, T. NUOVO)	

## BILAMA BCS "DUPLX" E "DUPLX GOLD"

Cod.	Descrizione prodotto	Immagini
23045	ASTA PER 12 DENTI DUPLEX DOPPI 3°/4° TIPO	
23048	BOCCOLA CONICA FLANGIATA 8x1,25 BCS DUPLEX 27226	
23049	BOCCOLA CONICA FLANGIATA Ø 8,2 BCS DUPLEX 27227	
23050	GUIDA INFERIORE DUPLEX 52127125- 52158589	
23051	PERNO-BOCCOLA ESPANSIONE BCS DUPLEX 27255	
23052	PREMILAMA DUPLEX 556327129	
23055	LAMA BCS DUPLEX 24 SEZIONI 1006	
23056	LAMA BCS DUPLEX 28 SEZIONI 1006	
23057	SEZIONE LAMA BCS DUPLEX SEMPLICE mm 2 27096	
23058	SEZIONE LAMA BCS DUPLEX DOPPIA 27120	
23070	TESTA LAMA PER SEZIONI DUPLEX 3°/4° TIPO BCS 28729	
23071	TESTA LAMA PER PETTINE DUPLEX 3°/4° TIPO BCS 28706	
23072	VITE TE M10X1,25X16 CON RONDELLA PER TESTA DUPLEX 28729	

Cod.	Descrizione prodotto	Immagini
23063	DENTE TRIPLO BCS DUPLEX 59027859	
23059	DENTE TRIPLO BCS DUPLEX 59028932	
23060	DENTE QUADRUPLO INIZIALE BCS DUPLEX 59027955	
23061	VITE PER DENTE DUPLEX TCE 8x1x12 CON RONDELLA	
23062	VITE PER DENTE DUPLEX TE 8x1x15 CON RONDELLA	
23064	DENTE DOPPIO DUPLEX 3°/4° TIPO "GOLD"	
23065	PREMILAMA DUPLEX GOLD 56528756Z	
23066	SEZIONE LAMA BCS DUPLEX SEMPLICE mm 2,7 28096	
23067	LAMA BCS DUPLEX 24 SEZIONI mm 2,7	
23068	LAMA BCS DUPLEX 28 SEZIONI mm 2,7	

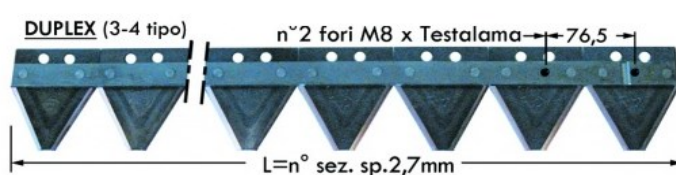
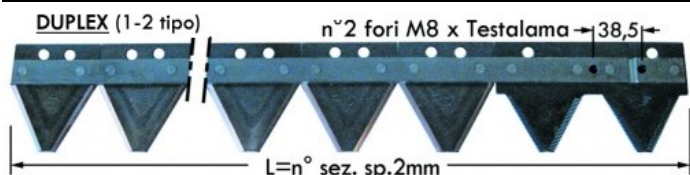

### INGRASSATORE MANUALE AZIONABILE CON UNA SOLA MANO

Ideale per raggiungere punti difficilmente accessibili.  
Funziona con cartucce commerciali da 400 gr.  
cartucce: diam.52 mm - lunghezza 245 mm.

Composto da:  
Ingrassatore manuale da 400 gr.  
Tubo erogazione R2 1/4" - L= 50 cm.  
Testina ingrassaggio a 4 griffe



MULTIPURPOSE EP2







Grasso al sapone di litio  
multigrasso per cuscinetti.

CARTUCCE da 400 grammi di grasso lubrificante  
(dimensioni cartucce diam.52 mm - lunghezza 245 mm)





## MOTOFALCIATRICE BERTOLINI

Cod.	Descrizione prodotto	Immagini
20500	ASTA CONSUMO 17 SEZIONI 582700 BERTOLINI	VEDI BCS
20510	ASTA CONSUMO 19 SEZIONI 582699 BERTOLINI	VEDI BCS
20520	ATTACCO LAMA 481-3 BERTOLINI	
20530	CONO BIELLA INFERIORE 961 BERTOLINI	
20540	CONO BIELLA SUPERIORE 962 BERTOLINI	
20550	DENTE FITTO 2689 BERTOLINI	VEDI BCS
20560	DENTE SEMIFITTO 2688 BERTOLINI	VEDI BCS
20590	GAMBO BIELLA FERRO 2287 BERTOLINI	
20600	GOMMINO BIELLA 963 BERTOLINI	
20610	LAMA RIGATA 15 SEZIONI BERTOLINI	
20620	LAMA RIGATA 17 SEZIONI BERTOLINI	
20630	LAMA RIGATA 19 SEZIONI BERTOLINI	

Cod.	Descrizione prodotto	Immagini
20640	PIASTRINA SCARPA DESTRA 982 BERTOLINI	
20650	PIASTRINA SCARPA SINISTRA 978 BERTOLINI	
20660	PREMILAMA 1 FORO 2686 BERTOLINI	VEDI BCS 2823
20670	PREMILAMA CAVALLOTTO 2685 BERTOLINI	VEDI BCS 2824
20680	PREMILAMA DESTRO 2274 BERTOLINI	
20690	PREMILAMA SINISTRO 2271 BERTOLINI	
20700	PREMISTRISCIA 2687 BERTOLINI	VEDI BCS 2828
20710	SPINOTTO TESTA BIELLA 223-1 BERTOLINI	
20720	TESTA BIELLA 2989 BERTOLINI	

## MINIFALCIATRICE BERTOLINI "PRATOLINA"

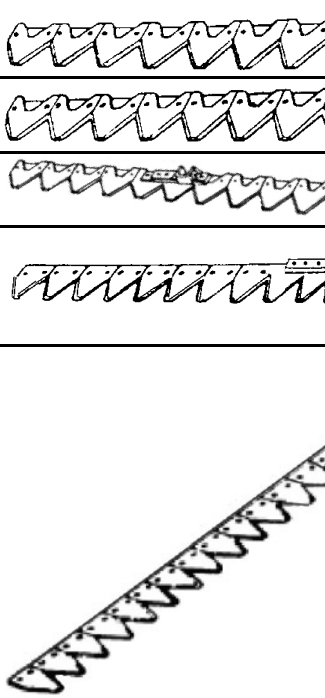
Cod.	Descrizione prodotto	Immagini
22820	SUPPORTO ATT. LAMA CENTRALE 2" BERTOLINI 107.3123 S. 134	
22825	SUPPORTO ATT. LAMA LATERALE 3" BERTOLINI 107.3122 S. 134	
22830	ATTACCO LAMA LATERALE A "U" 712045 BERTOLINI S. 134	
22834	LAMA 11 SEZIONI 3" ATT. LATERALE A "U" 712045 BERTOLINI S.134	
22835	LAMA 11 SEZIONI 3" ATT. LATERALE LISCIO 107.3133 BERTOLINI S.134	
22836	LAMA 15 SEZ. 3" ATTACCO CENTRALE BERTOLINI 712049	
22837	LAMA 23 SEZ. 2" (1073137) CON ATTACCO BERTOLINI S. 134	
22838	LAMA 25 SEZ. 2" (1073152) CON ATTACCO BERTOLINI S. 134	
22839	LAMA 23 SEZ. 2" (1073276) CON 2 PIOLINI BERTOLINI S. 134 T.N.	
22840	LAMA 25 SEZ. 2" (1073277) CON 2 PIOLINI BERTOLINI S. 134 T.N.	
22841	LAMA 29 SEZ. 2" (1073388) CON 2 PIOLINI BERTOLINI S. 134 T.N.	
22842	LAMA 23 SEZ. 2" (1073471) CON 1 PIOLINO BERTOLINI S. 134 T.N.	
22843	LAMA 25 SEZ. 2" (1073470) CON 1 PIOLINO BERTOLINI S. 134 T.N.	
22844	LAMA 27 SEZ. 2" (1073368) CON 1 PIOLINO BERTOLINI S. 134 T.N.	

Cod.	Descrizione prodotto	Immagini
22833	ATTACCO LAMA CENTRALE 107.3124 BERTOLINI S. 134	
22845	PREMILAMA 2 PUNTE CON VITE 8x20 BERTOLINI S. 134 111.3112	



# MOTOFALCIATRICI OLYMPIA - FIGARO - LAVERDA

Cod.	Descrizione prodotto	<b>OLYMPIA (Bedogni)</b>
20740	BIELLETTA NUDA 12177 OLYMPIA	
20750	CONO BIELLA SUPERIORE 12239 OLYMPIA	
20760	GOMMINO BIELLETTA 12292 OLYMPIA	
20770	LAMA RIGATA 17 SEZIONI 12280 OLYMPIA	
20780	TESTA BIELLA COMPLETA 12425 OLYMPIA	
20790	TESTA DI LAMA 953 OLYMPIA	

Cod.	Descrizione prodotto	<b>MFC LAVERDA</b>
20810	LAMA RIGATA 17 SEZIONI MFC-LAVERDA	
20820	LAMA RIGATA 19 SEZIONI LF167 MFC-LAVERDA	
20850	TESTA LAMA 3174760 MFC-LAVERDA	

## BILAME BUSATIS

Cod.	Descrizione prodotto	<b>BUSATIS - BIDUX</b>
22959	COPPIA LAME 1,50 BUSATIS (20-21 SEZ.)	
22960	COPPIA LAME 1,70 BUSATIS (22-23 SEZ.)	
22970	COPPIA LAME 1,90 BUSATIS (25-26 SEZ.)	
22975	SNODO INFERIORE BUSATIS 644000131	
22976	SNODO SUPERIORE BUSATIS 644000122	
22980	TESTA LAMA SUPERIORE BUSATIS GB 2741	
22981	TESTA LAMA INFERIORE BUSATIS GB 2742	
22990	ASTA FORATA 1,70 INFERIORE BUSATIS	
22991	ASTA FORATA 1,70 SUPERIORE BUSATIS	
23000	SEZIONE LISCIA BUSATIS	BUSATIS= INT. mm 38 - BIDUX=INT. mm 42
23010	SEZIONE PIOLO BUSATIS	
23020	SEZIONE FINALE BUSATIS	
23030	SEZIONE LISCIA BIDUX	
23040	SEZIONE PIOLO BIDUX	
23041	PREMILAMA INFERIORE CON SUPPORTO BUSATIS	
23042	PREMILAMA SUPERIORE BUSATIS	

ALTRI PARTICOLARI DELLA BILAMA BUSATIS SONO FORNIBILI A RICHIESTA

Cod.	Descrizione prodotto	<b>FIGARO (Nibbi)</b>
20860	ASTA CONSUMO FIGARO 18 SEZIONI	
20861	BIELLETTA 04256 FIGARO	
20870	CONO BIELLETTA 04266 FIGARO CON DENTINI	esaurito
20880	DENTE FITTO 4217A FIGARO	
20890	DENTE SEMIFITTO 4216A FIGARO	
20900	GOMMINO BIELLETTA 04265 FIGARO	
20910	LAMA RIGATA 15 SEZIONI FIGARO	
20920	LAMA RIGATA 18 SEZIONI FIGARO	
20930	PIASTRINA PULIZIA 04253 FIGARO	
20940	PREMILAMA 1 FORO FIGARO 04523	esaurito
20950	PREMILAMA A CAVALLOTTO FIGARO 04400	
20960	TESTA BIELLA COMPLETA 04233 FIGARO	
20970	TESTA LAMA 04267 FIGARO	

## LAME E RICAMBI ESM

Cod.	Descrizione prodotto	<b>SISTEMA DI TAGLIO ESM</b>
22900	DENTE SINGOLO ESM 3210040	
22902	DENTE DOPPIO ESM 3211040	
22903	DENTE DOPPIO ESM 3211010 (AEBI)	
22905	PREMILAMA ESM 3322050	
22907	TASSELLO ESM 3320670	
22910	PIASTRINA PULIZIA ESM 3320040	
22920	SEZIONE E.S.M. DOPPIA	
22930	SEZIONE E.S.M. DOPPIA CENTRALE	
22940	SEZIONE E.S.M. SEMPLICE - RM	
22947	LAMA ESM 0,81 2480030 ORIGINALE NORMALE	
22948	LAMA ESM 0,81 2490850 ORIGINALE ATTACCO LUNGO	
22949	LAMA ESM 0,86 2481350 ORIGINALE NORMALE	
22950	LAMA ESM 0,96 2481360 ORIGINALE NORMALE	
22951	LAMA ESM 0,96 2481370 ORIGINALE TIPO NUOVO	
22952	LAMA ESM 1,02 2480020 ORIGINALE NORMALE	
22953	LAMA ESM 1,07 2481040 ORIGINALE NORMALE	
22955	LAMA ESM 1,17 2481050 ORIGINALE NORMALE	
22956	LAMA ESM 1,37 2481060 ORIGINALE NORMALE	

## BARRA GASPARDO TIPO VECCHIO

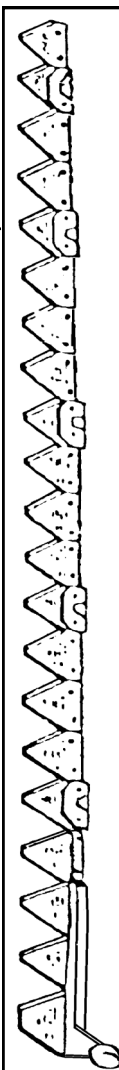
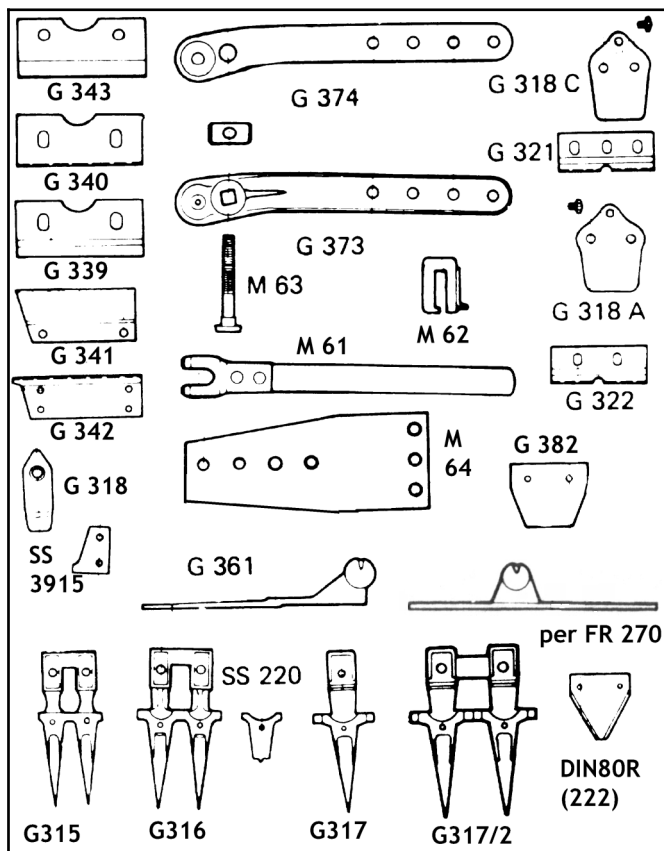

20980	ASTA FORATA 20 SEZIONI G 380A GASPARDO	
20985	ASTA FORATA 34 SEZIONI PER LAMA GASPARDO FR 270	
20990	ATTACCO BIELLA G373 GASPARDO	
21000	ATTACCO BIELLA G374 GASPARDO	
21010	BULLONE CON DADO CILINDRICO M63 GASPARDO	
21020	BULLONE SINISTRO CON DADO A CRICCA GASPARDO	
21030	DENTE DOPPIO NORMALE GASPARDO G317-2	
21040	DENTE FITTO G315 GASPARDO	
21060	DENTE SEMIFITTO G316 GASPARDO	
21070	FALSA SEZIONE G362 GASPARDO	
21080	GUIDA ANTERIORE G341 GASPARDO	
21090	GUIDA POSTERIORE G343 GASPARDO	
21110	LAMA RIGATA 20 SEZIONI GASPARDO	
21115	LAMA RIGATA 34 SEZIONI GASPARDO FR 270 COD. 1006	
21116	LAMA RIGATA 24 SEZIONI GASPARDO FR 270 COD. 15-042	
21117	LAMA RIGATA 40 SEZIONI GASPARDO FR 270	
21120	PIASTRA A 4 FORI G342 GASPARDO	
21130	PIASTRA BIELLA M64 GASPARDO	
21140	PIASTRA CONSUMO FITTA G321 GASPARDO	
21150	PIASTRA CONSUMO SEMIFITTA G322 GASPARDO	
21160	PIASTRA SCARPA ESTERNA SS3915 GASPARDO	
21170	PIASTRA SCARPA G339 GASPARDO	
21180	PIASTRA SCARPA G340 GASPARDO	
21200	PIASTRINA DENTE SEMIFITTO SS220 GASPARDO	
21210	PIASTRINA PULIZIA G319 GASPARDO	
21220	PREMILAMA 1 FORO G318 GASPARDO	
21230	PREMILAMA 2 FORI FITTO G318C GASPARDO	
21240	PREMILAMA 2 FORI SEMIFITTO G318A GASPARDO	
21250	SEZIONE RIGATA DIN 80 R GASPARDO	
21260	SQUADRETTA BIELLA M62 GASPARDO	
21270	TESTA LAMA G361 GASPARDO	
21275	TESTA LAMA FR 270 GASPARDO	
21280	UNGHETTA CON LAMA ACCIAIO M61 GASPARDO	

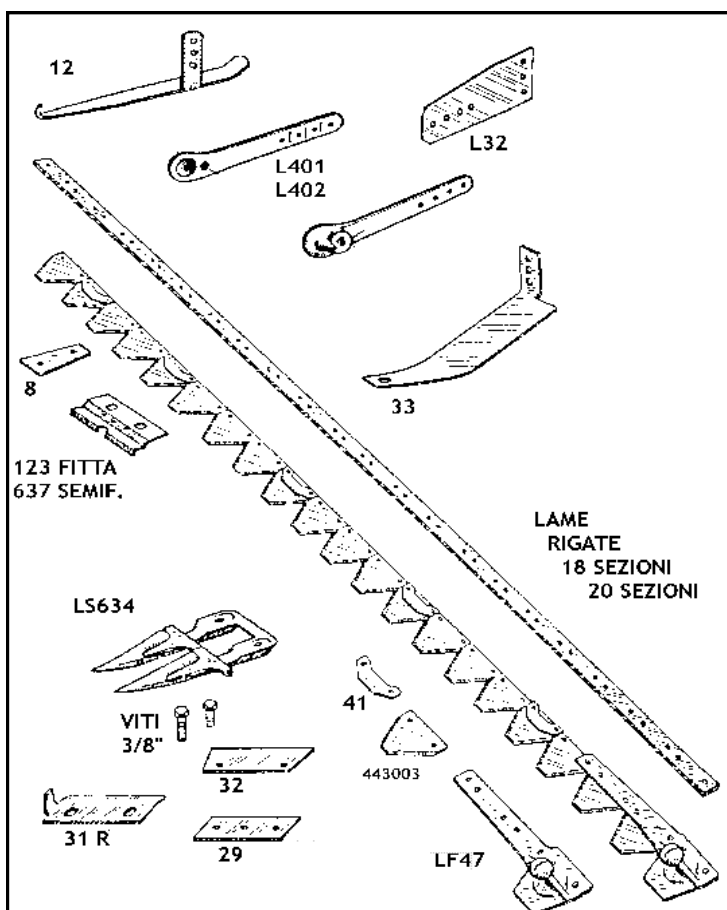

## BARRA LAVERDA TIPO VECCHIO

21630	ASTA FORATA 20 SEZIONI LAVERDA	
21660	DENTE SEMIFITTO LS 634 LAVERDA	
21680	GUIDA TIPO NUOVO 31R LAVERDA	
21690	LAMA ACCIAIO PER BIELLA L32 LAVERDA	
21700	LAMA RIGATA 18 SEZIONI 43 LAVERDA	
21710	LAMA RIGATA 20 SEZIONI 43C LAVERDA	
21720	PIASTRA CONSUMO FITTA 123 LAVERDA	
21730	PIASTRA CONSUMO SEMIFITTA 637 LAVERDA	
21740	PIASTRA SCARPA 3 FORI 29 LAVERDA	
21770	PIASTRINA DENTE SEMIFITTO 636 LAVERDA	
21780	PIASTRINA PULIZIA 41 LAVERDA	
21830	SEZIONE RIGATA 443003 LAVERDA	
21831	SEZIONE RIGATA LAVERDA (RIGATURA INTERA)	
21870	TESTA LAMA 47 LAVERDA	

**AVVISO: TUTTI I PARTICOLARI DI QUESTA PAGINA SONO AD ESAURIMENTO, QUINDI NON SE NE GARANTISCE LA REPERIBILITA'. I PREZZI POSSONO VARIARE SENZA OBBLIGO DI COMUNICAZIONE.**

## BARRA FALCIANTE G&S TIPO VECCHIO

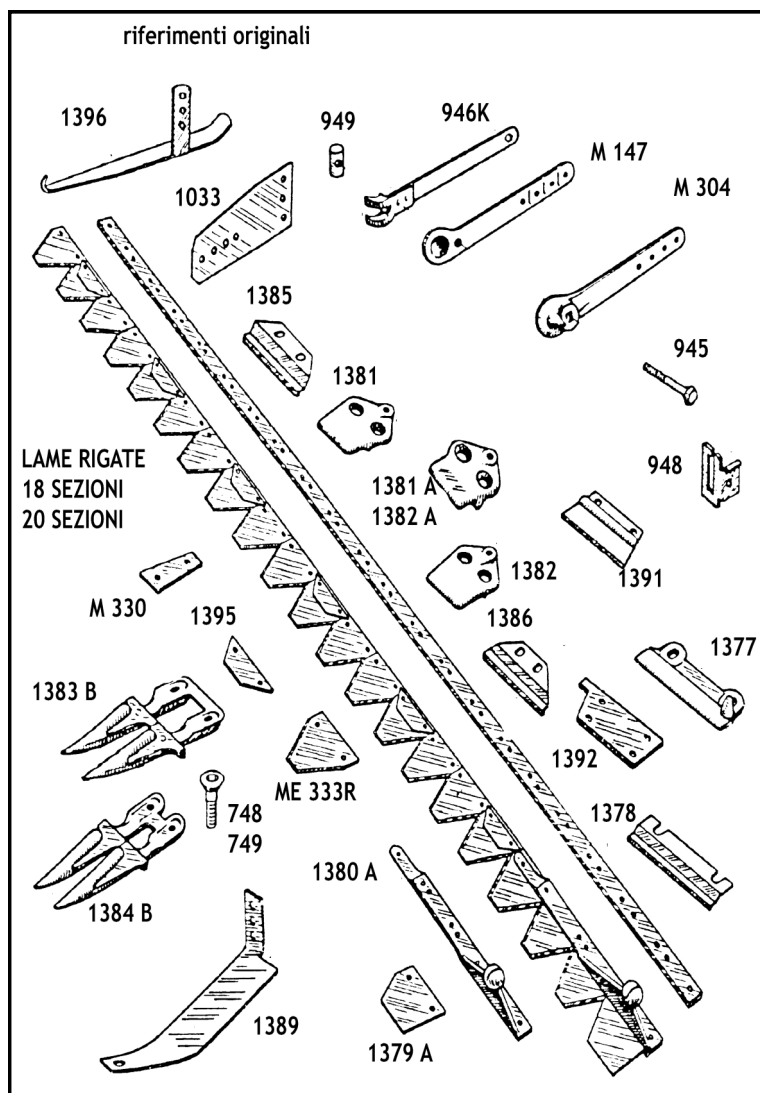

21300	ASTA FORATA 20 SEZIONI G&S	
21310	ATTACCO BIELLA M147 G&S	
21320	ATTACCO BIELLA M304 G&S	
21330	BULLONE CON DADO CILINDRICO 998 G&S	
21340	DENTE FITTO 1384B G&S	
21350	DENTE SEMIFITTO 1383B G&S	
21360	FALSA SEZIONE 1379A G&S	
21370	GUIDA ANTERIORE 1391 G&S	
21380	GUIDA POSTERIORE 1377 G&S	
21390	LAMA ACCIAIO PER BIELLA 74 G&S	
21410	LAMA RIGATA 20 SEZIONI 500801 G&S	
21415	LAMA RIGATA 22 SEZIONI G&S	
21420	PIASTRA ANTERIORE 1392 G&S	
21430	PIASTRA CONSUMO FITTA 1386 G&S	
21440	PIASTRA CONSUMO POSTERIORE 1378 G&S	
21450	PIASTRA CONSUMO SEMIFITTA 1385 G&S	
21460	PIASTRINA DENTE FITTO 1393 G&S OR.	
21470	PIASTRINA DENTE SEMIFITTO 1394 G&S OR.	
21480	PIASTRINA PULIZIA 1395 G&S	
21490	PIASTRINA SCARPA ESTERNA M330 G&S	
21500	PREMILAMA FITTO REG. 1382 G&S	
21510	PREMILAMA G.T. FITTO 1382A G&S	
21520	PREMILAMA G.T. SEMIFITTO 1381A G&S	
21530	PREMILAMA SEMIFITTO REG. 1381 G&S	
21540	SEZIONE RIGATA ME333 G&S	
21550	SQUADRETTA 948 G&S	
21560	SUOLA ESTERNA 1396 G&S	
21570	SUOLA INTERNA 1389 G&S	
21580	TESTA DI LAMA 1380A G&S	
21590	UNGHIETTA CON LAMA ACCIAIO 946K G&S	
21600	VITE PER DENTE 10x28 749 G&S	
21610	VITE PER DENTE 10x36 748 G&S	

**AVVISO: I PARTICOLARI DELLA BARRA F. G&S SONO AD ESAURIMENTO, QUINDI NON SE NE GARANTISCE LA REPERIBILITA'. I PREZZI POSSONO VARIARE SENZA OBBLIGO DI COMUNICAZIONE.**













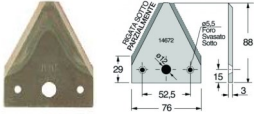

23080	RIBATTINI TESTA SVASATA 5,2x14		1 kg
23082	RIBATTINI TESTA SVASATA 5,2x18		1 kg
23084	RIBATTINI TESTA SVASATA 5,2x20		1 kg
23088	RIBATTINI TESTA SVASATA 5,2x25		1 kg
23090	RIBATTINI TESTA SVASATA 5,2x28		1 kg
23092	RIBATTINI TESTA SVASATA 6x14		1 kg
23096	RIBATTINI TESTA SVASATA 6x20		1 kg
23098	RIBATTINI TESTA SVASATA 6x25		1 kg
23100	RIBATTINI TESTA SVASATA 6,4x15		1 kg
23102	RIBATTINI TESTA SVASATA 7x20		1 kg
23104	RIBATTINI TESTA SVASATA 7x25		1 kg
23106	RIBATTINI TESTA BOMBATA 6x16 - 6x20 - 6x25		1 kg

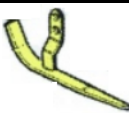

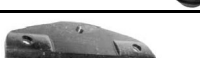





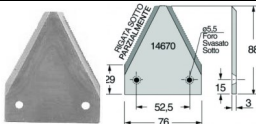

















## BILAME G&S SUPERIOR 72 E SUPERIOR 394

Cod.	Descrizione prodotto	72
22265	ASTA FORATA PER LAMA A 14 DENTI SUPERIOR	
22275	ASTA FORATA PER LAMA A 28 SEZIONI SUPERIOR	
22280	BOCCOLA mm 19 099 SUPERIOR	
22290	BOCCOLA mm 25 14337 SUPERIOR	
22300	BULLONE PER TESTA LAMA 8114 SUPERIOR	
22303	CUSCINETTO LEVA SUPERIOR 096	
22310	DENTE DOPPIO FORO mm 5,5 088 SUPERIOR	
22320	DENTE DOPPIO FORO mm 7,5 087 SUPERIOR	
22330	GUIDA CONSUMO INFERIORE 029 SUPERIOR 182	
22331	GUIDA CONSUMO INFERIORE 029 SUPERIOR 212	
22340	GUIDA CONSUMO SUPERIORE 030 SUPERIOR 182	
22341	GUIDA CONSUMO SUPERIORE 030 SUPERIOR 212	
22350	GUIDA TESTA INFERIORE 029B SUPERIOR	
22360	LAMA 12 DENTI 016-182	
22370	LAMA 14 DENTI 016-212	
22380	LAMA 24 SEZIONI 017-182	
22390	LAMA 28 SEZIONI 017-212	
22395	MOLLONE PER BARRA SUPERIOR	
22400	PREMILAMA 028 SUPERIOR	
22410	PREMILAMA DI TESTA 027 SUPERIOR	
22420	PREMILAMA TERMINALE 028A SUPERIOR	
22425	GRANO DI REGISTRO 8119 SUPERIOR PER PREMIL. 028	
22426	GRANO DI REGISTRO 998 SUPERIOR PER PREMIL. 028A	
22427	BULLONE TPSV C/DADO 093-094 TV SUPERIOR	
22428	BULLONE TTQST 12x45 093-094 TIPO NUOVO	
22429	RULLO TENDICINGHIA 8214 SUPERIOR	
22432	SPARTIERBA INTERNO 033	

Cod.	Descrizione prodotto	72
22430	SEZIONE RIGATA 036 SUPERIOR	
22435	SCARPA ESTERNA SUPERIOR 034-8264	
22436	SLITTA SCARPA ESTERNA 035 SUPERIOR	
22438	SLITTA INTERNA 024 SUPERIOR	
22440	TESTA PER LAMA A DENTI 016-A SUPERIOR (=SUPERIOR 394)	
22450	TESTA PER LAMA A SEZIONI 017-A SUPERIOR	

Cod.	Descrizione prodotto	394
22465	BULLONE TQ 2014 PER SLITTA ESTERNA SUPERIOR 394	
22470	LAMA 24 SEZIONI 14512	
22472	LAMA 28 SEZIONI 14513	
22475	LAMA 12 DENTI 14502	
22477	LAMA 14 DENTI 14503	
22478	SEZIONE RIGATA 3 FORI SUPERIOR 394	
22479	TESTA LAMA PER SEZIONI 14294 SUPERIOR 394	
22480	SLITTA SCARPA ESTERNA T. N. (ORIG. GS 8265) SUPERIOR 394	
22481	SCARPA ESTERNA (3 FORI Q.) 14347 SUPERIOR 394	
22482	VITE TESTA LAMA 14295	
22483	GRANO CON DADO 14674	
22484	PREMILAMA DOPPIO 14285 SUPERIOR 394	
22485	PREMILAMA TERMINALE 14319 SUPERIOR 394	
22486	GUIDA SOTTOTESTA 14336 SUPERIOR 394	
22487	GUIDA INFERIORE 14282 SUPERIOR 394	
22488	PREMILAMA SINGOLO 14286 SUPERIOR 394	
22489	SEZIONE RIGATA SUPERIOR 394 2 FORI SVASATI SOTTO	

# BILAMA GASPARDO " F B 9 2 5 "

Cod.	Descrizione prodotto	FB 925
21900	ASTA FORATA PER LAMA A 12 DENTI FB925	
21905	ASTA FORATA PER LAMA A 14 DENTI FB925	
21910	ASTA FORATA PER LAMA A 24 SEZIONI FB925	
21915	ASTA FORATA PER LAMA A 28 SEZIONI FB925	
21920	BOCCOLA BRONZO 21120067 PER L. C. FB 925	
21930	BOCCOLA PER TESTA LAMA 21120048 FB925	
21932	BULLONE ANDANA CON MOLLA 21120133 FB925	
21933	ANELLO INTERNO CUSCINETTO FB925 21120137	
21935	CUSCINETTO A RULLI FB925 51127001	
21936	RONDELLA FB925 20970519	
21945	DENTE DOPPIO 21120066 FB925 RM (Ø FORO mm 5,25)	
21950	GUIDA ESTERNA 21120039 FB925	
21960	GUIDA INTERNA INFERIORE 21120045 FB925	
21970	GUIDALAMA INTERNA SUPERIORE 21120043 FB925	
21980	GUIDALAMA INFERIORE 21120042 FB925	
21990	GUIDALAMA SUPERIORE 21120041 FB925	
22000	LAMA 12 DENTI 21120053 FB925	
22010	LAMA 14 DENTI 21120106 FB925	
22020	LAMA 24 SEZIONI 21120049 FB925	
22030	LAMA 28 SEZIONI 21120102 FB925	
22040	LAMA CERNIERA (BIELLA) CON BOCCOLE 21120070 FB925 E ALTRI MODELLI	
22261	BIELLA ESTERNA FB925 FB940	
22262	KIT CUSCINETTO COMPLETO PER BIELLA ESTERNA FB925 FB940	
22045	MOLLONE PER BARRA FB 925 940	
22050	PERNO AD ESPANSIONE 21120069 FB925	

Cod.	Descrizione prodotto	FB 925
22051	RULLO TENDICINGHIA 21120121 FB925	
22058	SCARPA INTERNA FB 925 21120034	
22059	PROTEZIONE CERNIERA (SPARTIERBA) FB 925 21120036	
22060	SCARPA ESTERNA (EX 21120037 ORA 19200903) FB925	
22061	SLITTA SCARPA ESTERNA 21120038 FB925	
22062	SLITTA SCARPA INTERNA 21120035 FB 925	
22063	VITE TQ 11x30 CON DADO PER SLITTA FB 925	
22065	ASSE ANDANA FB925 FB940 COMPLETA DI BASTONE 21120134 20800061	
22070	SEZIONE RIGATA 21120065 FB925	 
22090	TESTA PER LAMA A DENTI 21120052 FB925	
22100	TESTA PER LAMA A SEZIONI 21120046 FB925	
22110	VITE E DADO CONICO PERNO ESP. 0071 0068 FB 925	
22258	CINGHIA PER FB925 FB940	
22259	BASTONE ANDANA FB925 FB940	

**DELLE BILAME GASPARDO FB 925 FB 940 FBR POSSIAMO FORNIRE SU RICHIESTA ANCHE PARTICOLARI NON PRESENTI IN QUESTO CATALOGO**

## BILAME GASPARDO "FB 940" E "FBR" (VITI)









Cod.	Descrizione prodotto	FB 940
22120	ASTA FORATA PER LAMA A 12 DENTI FB940	
22125	ASTA FORATA PER LAMA A 14 DENTI FB940	
22130	ASTA FORATA PER LAMA A 24 SEZIONI FB940	
22135	ASTA FORATA PER LAMA A 28 SEZIONI FB940	
22140	DENTE DOPPIO FORO mm 6,25 21120268 FB940 RM	Ø FORO mm 6,25
22141	DENTE DOPPIO FORO PUNTE STRETTE mm 6,25 21120260 FB940	
22145	GUIDALAMA INTERNO SUPERIORE 21120312 FB 940	
22150	GUIDALAMA SUPER. EST. SALDATO FB 940 21120113	
22160	GUIDALAMA SUPERIORE FB 940 ALTO 21120232	
22170	GUIDALAMA SUPERIORE TRIPLO FB 940 21170065	
22211	LAMA 12 DENTI 21120256 FB940	
22212	LAMA 14 DENTI 21120257 FB940	
22213	LAMA 24 SEZIONI 21120240 FB940	
22214	LAMA 28 SEZIONI 21120241 FB940	
22230	SEZIONE RIGATA FORO mm 6,25 21120243 FB940	
22251	TESTA PER LAMA A DENTI FB940 21120259	
22252	TESTA PER LAMA A SEZIONI FB940 21120267	
22253	PROTEZIONE CERNIERA (SPARTIERBA) FB 940 21120322	
22254	SCARPA INTERNA FB 940 21120323	
22255	SLITTA SCARPA INTERNA FB940 21120029 TIPO VECCHIO	
22257	SLITTA SCARPA INTERNA FB940 21120324 TIPO LARGO (NUOVO)	

Cod.	Descrizione prodotto	FBR (VITI)
21880	DENTE DOPPIO FILETTATO GASPARDO FBR 13013270 (2 FORI)	
21881	DENTE DOPPIO GASPARDO FBR (h 112) 13013830	
21882	VITE 8x1x12 PER DENTE GASPARDO FBR	
21883	ROSETTA ELASTICA Ø 8 PER DENTE GASPARDO FBR	€ 0,16
21885	ASTA FORATA PER DENTI CON TESTA LAMA MONTATA GASPARDO FBR	
21886	GUIDALAMA INFERIORE SINGOLA GASPARDO FBR 13013511	
21887	GUIDALAMA SUPERIORE ALTA GASPARDO FBR 19203311	
21888	GUIDALAMA SUPERIORE GASPARDO FBR 19203301	
21889	GUIDA INTERNA DOPPIA GASPARDO FBR 13013151	
21890	LAMA 14 DENTI GASPARDO FBR 13013270	
21891	LAMA 28 SEZIONI GASPARDO FBR 13013590	
21892	TESTA LAMA PER DENTI GASPARDO FBR 13013230	
21893	TESTA LAMA PER SEZIONI GASPARDO FBR 13013190	
21895	SEZIONE DOPPIA RIG. SOPRA (SV. SOTTO 13013550 SV. SOPRA 13013540)	

**DELLE BILAME GASPARDO FB 925—FB 940—FBR POSSIAMO FORNIRE SU RICHIESTA ANCHE PARTICOLARI NON PRESENTI IN QUESTO CATALOGO**

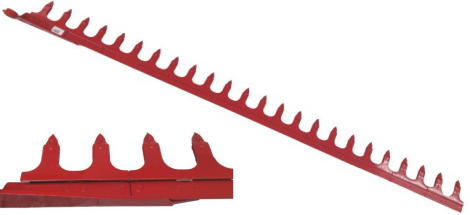
# RICAMBI ORIGINALI BILAME GASPARDO

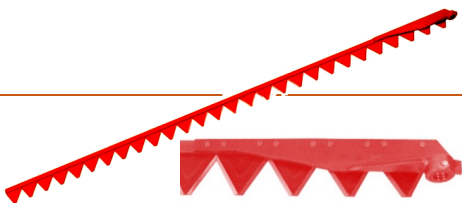
Codice	Descrizione RICAMBI ORIGINALI
21885G	ASTA FORATA PER DENTI CON TESTA LAMA FBR 13013340 
21887G	GUIDALAMA SUPERIORE ALTA FBR 19203311 
21888G	GUIDALAMA SUPERIORE FBR 19203301 
21920G	BOCCOLA BRONZO 21120067 PER LAMA CERNIERA FB925 
21932G	BULLONE ANDANA CON MOLLA 21120133 FB925 
21933G	ANELLO INTERNO CUSCINETTO FB925 21120137 
21960G	GUIDA INTERNA INFERIORE 21120045 FB925 
21980G	GUIDALAMA INFERIORE 21120042 FB925 
21990G	GUIDALAMA SUPERIORE 21120041 FB925 
22000G	LAMA 12 DENTI 21120053 FB925 
22010G	LAMA 14 DENTI 21120106 FB925 
22040G	LAMA CERNIERA CON BOCCOLE 21120070 
22060G	SCARPA ESTERNA 19200903 FB925 
22061G	SLITTA SCARPA ESTERNA 21120038 FB925 

Codice	Descrizione RICAMBI ORIGINALI
22065G	ASSE ANDANA FB925 FB940 COMPL. DI BASTONE 21120134 20800061 
22120G	ASTA FORATA PER LAMA A 12 DENTI FB940 21120251 
22125G	ASTA FORATA PER LAMA A 14 DENTI FB940 21120252
22130G	ASTA FORATA PER LAMA A 24 SEZIONI FB940 21120246
22135G	ASTA FORATA PER LAMA A 28 SEZIONI FB940 21120247
22140G	DENTE DOPPIO FORO mm 6,25 21120268 FB940 
22141G	DENTE DOPPIO FORO PUNTE STRETTE mm 6,25 21120260 FB940 
22111G	LAMA 12 DENTI 21120256 FB940 
22212G	LAMA 14 DENTI 21120257 FB940
22213G	LAMA 24 SEZIONI 21120240 FB940 
22214G	LAMA 28 SEZIONI 21120241 FB940 
22230G	SEZIONE RIGATA FORO mm 6,25 21120243 FB940 
22257G	SLITTA SCARPA INTERNA FB940 21120324 TIPO LARGO (NUOVO) 

**Novità! 2019**

**RICAMBI ORIGINALI MASCHIO GASPARDO**

PREVENTIVI SU RICHIESTA PER OGNI ALTRO ARTICOLO



## MINIFALCIATRICI S E P

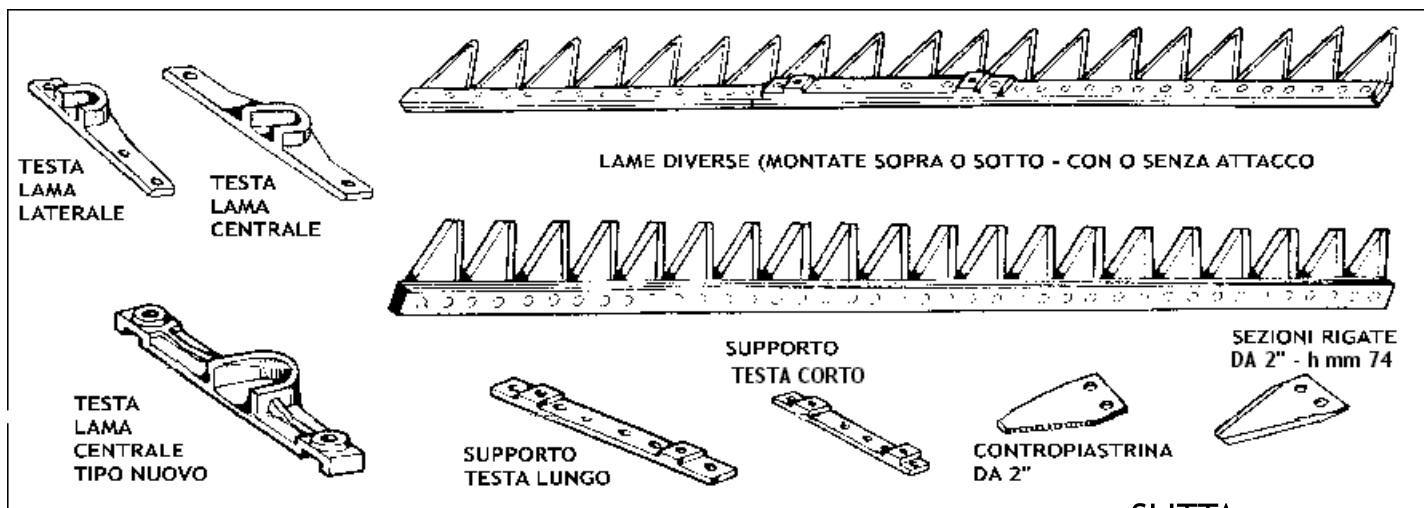

Cod.	Descrizione prodotto
22846	CONTROPIASTRINA A DENTE 2" - 206792 SEP
22849	LAMA 19 SEZ. 2" (M. SOPRA) SENZA ATTACCO 4 FORI SEP
22850	LAMA 22 SEZ. 2" (M. SOPRA) SENZA ATTACCO 2 FORI SEP
22851	LAMA 22 SEZ. 2" (M. SOTTO) SENZA ATTACCO 2 FORI SEP
22852	LAMA 22 SEZ. 2" (M. SOTTO) CON ATTACCO SEP
22854	LAMA 24 SEZ. 2" (M. SOTTO) SENZA ATTACCO 4 FORI SEP
22855	LAMA 24 SEZ. 2" (M. SOTTO) CON ATTACCO LUNGO SEP
22856	LAMA 28 SEZ. 2" (M. SOTTO) SENZA ATTACCO 2 FORI SEP

Cod.	Descrizione prodotto
22857	LAMA 28 SEZ. 2" (M. SOTTO) CON ATTACCO LUNGO SEP
22858	SEZIONE RIG. 2" h-mm 74 - 2 F. mm 5,5 - 2001-74 SEP
22859	SLITTA REGISTRABILE Dx-Sx SEP 43572
22860	SUPPORTO TESTA LUNGO SEZ. 2" 210464 SEP
22861	SUPPORTO TESTA SEZ. 3" 209006 SEP
22865	TESTA LAMA CENTRALE 203318 SEP
22866	TESTA LAMA CENTRALE 209005 SEP T. NUOVO
22867	TESTA LAMA LATERALE 203317 SEP

## FALCIATRICI DIVERSE

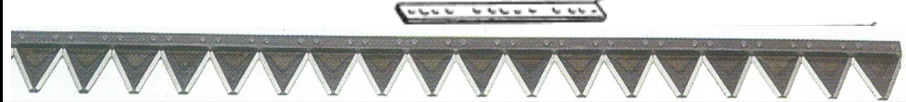
Cod.	Descrizione prodotto	
22868	LAMA 23 SEZ. 2" (M. SOPRA) SENZA ATT. 2 FORI BARBIERI	
22869	LAMA RIGATA 13 SEZIONI 3" ROTECO	
22870	LAMA 22 SEZ. 2" (M. SOPRA) SENZA ATTACCO 4 FORI BENASSI	
22871	TESTA LAMA BENASSI PER ESM	
22880	LAMA 15 SEZ. 3" 60459 COLIBRI	
22885	TESTA LAMA CENTRALE 60422 COLIBRI	
22887	LAMA RIGATA 19 SEZIONI 2" CARRARO-EUROSYSTEMS	
22888	LAMA RIGATA 23 SEZIONI 2" CON P. P. 2 FORI CASORZO	

## LAME TIPO " L V B " (SEZIONI TIPO ESM)

Cod.	Descrizione prodotto
22889	Ssezione 2" 21485 (CAVALLI)
	LAME TIPO LVB MISURE CORTE A RICHIESTA, SECONDO DISPONIBILITA'
	LAME TIPO LVB MISURE LUNGHE A RICHIESTA, SECONDO DISPONIBILITA'
22893	PIASTRINA PULIZIA DOPPIA PER 2" ESM TIPO LVB 621101
22894	PIASTRINA PULIZIA SINGOLA PER 3" ESM TIPO LVB 1250R

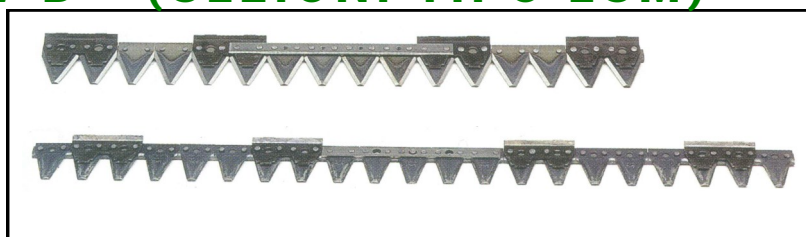

**AVVISO: TUTTI I PARTICOLARI DI QUESTA PAGINA SONO AD ESAURIMENTO, QUINDI NON SE NE GARANTISCE LA REPERIBILITA'. I PREZZI POSSONO VARIARE SENZA OBBLIGO DI COMUNICAZIONE.**

# FALCIATRICI ROTATIVE (NOTTOLINI, PIATTELLI, BULLONI P.C.)

<b>BELLON</b>	<b>CLAAS</b>	<b>FAHR-FORT-MARANGON</b>	<b>FAHR 2° TIPO</b>	<b>FELLA</b>
<b>GALFRE'</b>	<b>LINCE</b>	<b>MARANGON DISCHETTI</b>	<b>P Z Ø 18 (185)</b>	<b>P Z Ø 20 (165)</b>
<b>SUPERTINO</b>	<b>RONDELLA CENTRAGGIO</b>	<b>BELLON T. VECCHIO -</b>	<b>FELLA 2° TIPO</b>	<b>FELLA 3° TIPO</b>
<b>KRONE 2° TIPO</b>	<b>KUHN 1° TIPO - FORT Ø 16</b>	<b>KUHN 2° TIPO Ø 18</b>	<b>NIEMEYER 1° TIPO</b>	<b>NIEMEYER 2° TIPO</b>
<b>POTTINGER</b>	<b>VICON ECCENTRICO</b>	<b>TAARUP Ø 20</b>	<b>CLAAS 3° TIPO—KRONE</b>	<b>FELLA 1° TIPO</b>
<b>BCS 1° TIPO</b>	<b>BCS 2° TIPO</b>	<b>BCS 3° TIPO</b>	<b>KRONE 1° TIPO</b>	<b>RASSPE</b>
<b>VICON—FAHR 2° T. Ø 18</b>	<b>GRIBALDI &amp; SALVIA</b>	<b>BELLON TIPO NUOVO</b>	<b>KRONE EASY CUT 253108.3</b>	<b>POTTINGER 310 T</b>

Cod.	Descrizione prodotto	Cod.	Descrizione prodotto	Cod.	Descrizione prodotto
23170	NOTTOLINO P.C. BELLON	23235	NOTTOLINO P.C. SUPERTINO	23286	BULLONE P.C. POTTINGER 310 T
23180	NOTTOLINO P.C. CLAAS	23238	BULLONE P.C. BELLON T.V.- COMER	23290	BULLONE P.C. VICON ECCENTRICO
23190	NOTTOLINO P.C. FAHR-FORT-MORRA-MARANGON	23239	PIATTELLO P.C. BELLON TIPO NUOVO	23293	BULLONE P.C. VICON - FAHR 2° TIPO (Ø 18)
23192	NOTTOLINO P.C. FAHR 2° TIPO	23240	BULLONE P.C. FELLA 2° TIPO	23295	BULLONE P.C. CLAAS - KRONE 3° TIPO
23195	NOTTOLINO P.C. FELLA	23245	BULLONE P.C. FELLA 3° TIPO	23297	BULLONE P.C. TAARUP (Ø 20)
23200	NOTTOLINO P.C. GALFRÈ	23250	BULLONE P.C. KRONE 2° TIPO	23298	BULLONE P.C. G & S
23210	NOTTOLINO P.C. LINCE	23255	BULLONE P.C. KRONE EASY CUT 253108.3	23300	PIATTELLO P.C. BCS 1° TIPO CON VITE 10 MA
23215	NOTTOLINO P.C. MARANGON T. NUOVO (DISCHETTI)	23260	BULLONE P.C. KUHN - FORT mm 16 - M10	23305	PIATTELLO P.C. BCS 2° TIPO CON VITE 10 MA
23220	NOTTOLINO P.C. P.Z. Ø mm 18 (185)	23270	BULLONE P.C. KUHN mm 18 - M12	23306	PIATTELLO P.C. BCS 3° TIPO CON VITE 10 MB
23230	NOTTOLINO P.C. P.Z. Ø mm 20 (165)	23280	BULLONE P.C. NIEMEYER	23308	PIATTELLO P.C. FELLA 1° TIPO CON VITE 10 MB
		23282	BULLONE P.C. NIEMEYER (TIPO A VITE Ø 22)	23320	PIATTELLO P.C. KRONE 1° TIPO CON VITE 10 MA
		23285	BULLONE P.C. POTTINGER 260/290/310	23330	PIATTELLO P.C. RASSPE
				23530	RONDELLA CENTRAGGIO FAHR

# FALCIATRICI ROTATIVE (PIASTRE PORTA-COLTELLO)

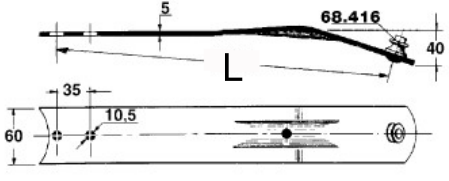
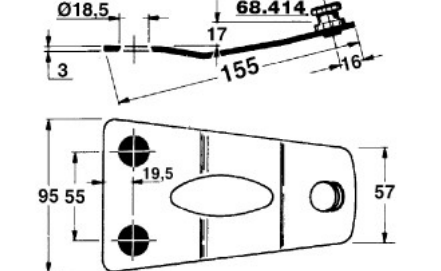
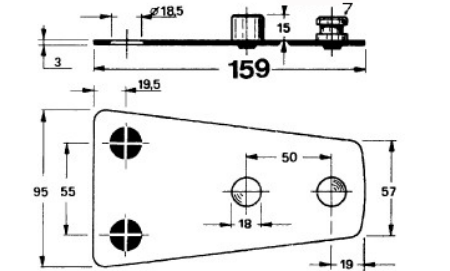
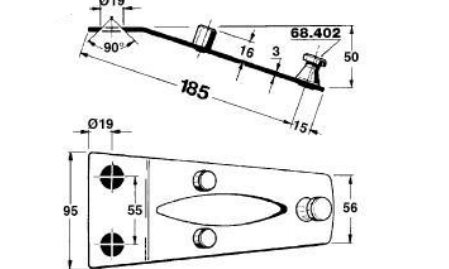
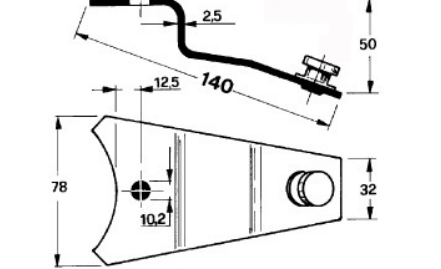
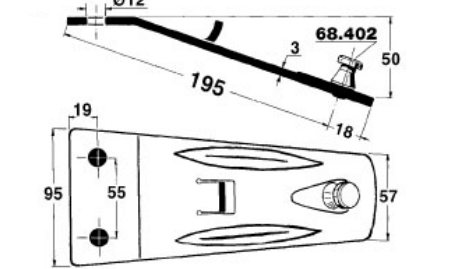
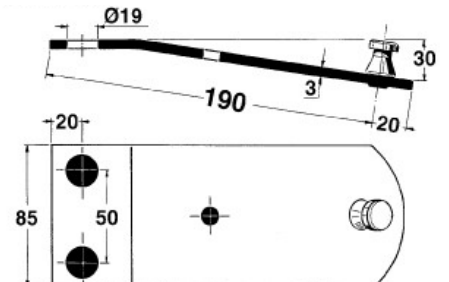
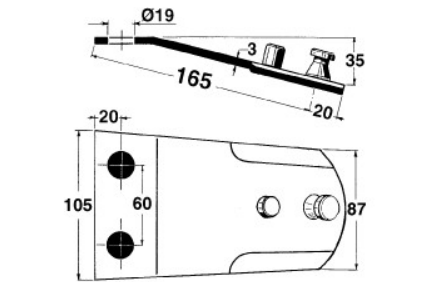
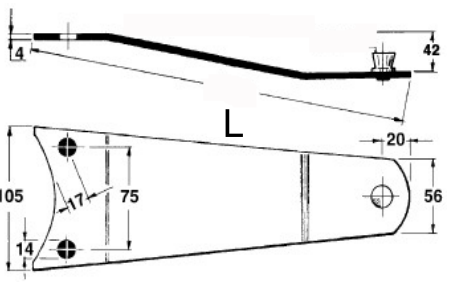
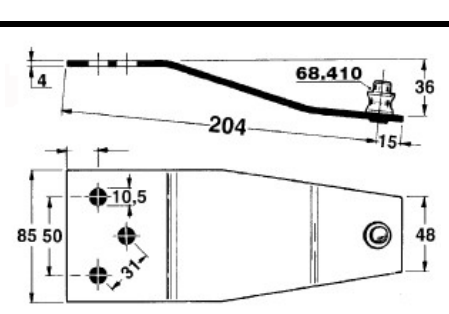
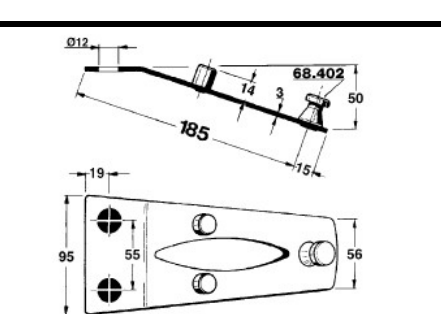
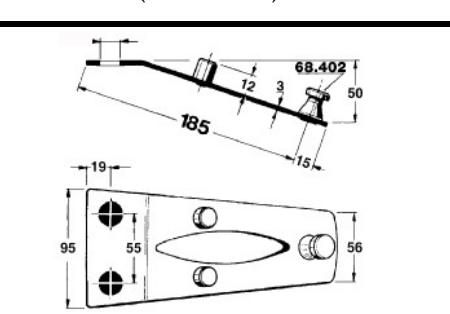
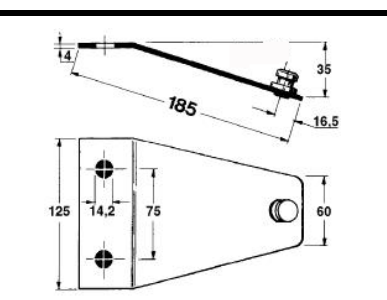
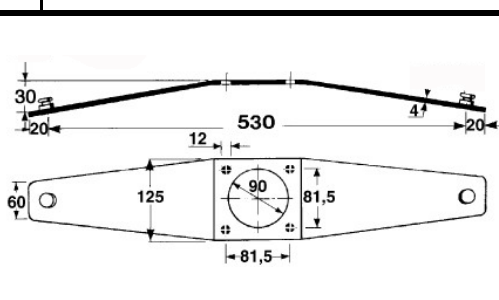
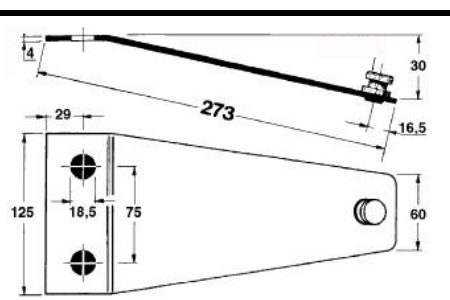
 <p>misura L    135=mm 155    -    170=mm 285      190=mm 320    -    210=mm 350</p>		
<p>BELLON 135-170-190-210</p>	<p>CLAAS PRIMO TIPO</p>	<p>CLAAS SECONDO TIPO</p>
		
<p>FAHR KM 22-FKHR KM 24 FORT 165-FORT 185 - AMA 165</p>	<p>FAHR 4 TAMBURI P.Z. TIPO VECCHIO</p>	<p>FAHR TIPO NUOVO KM 2.17 - KM 2.19</p>
		
<p>FELLA LUNGA TIPO VECCHIO</p>	<p>FELLA CORTA TIPO NUOVO</p>	<p>GALFRE' 165 (L = mm 295) GALFRE' 185 (L = mm 340)</p>
		
<p>LINCE (UGUALE PER TUTTI I MODELLI)</p>	<p>MARANGON (MODELLI 2000 E 2500)</p>	<p>MORRA PRIMO TIPO ( FORI Ø mm 19) MORRA SECONDO TIPO (FORI Ø mm 15)</p>
		
<p>P. Z. ZWEEGERS 185 (CORTA)</p>	<p>P. Z. ZWEEGERS 135 (DOPPIA LUNGA)</p>	<p>P. Z. ZWEEGERS 165 (LUNGA)</p>

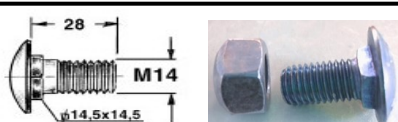

**BULLONE SPECIALE TTQST M 14x35 PER PIASTRE P.C. PZ 185**  
**COD. 23535**

## FALCIATRICI ROTATIVE (PIASTRE PORTA-COLTELLO)

<p>FAHR KM 20 (0658.0109)</p>	<p>MARANGON 2° TIPO (DISCHETTI)</p>	<p>NIEMEYER 165</p>
<p>CLAAS 210 3° TIPO</p>	<p>PZ ZWEEGERS 210 (MEDIA)</p>	<p>POTTINGER LUNGA</p>
<p>NIEMEYER 570.441</p>	<p>CLAAS CORTA CON PIEGA</p>	<p>POTTINGER CAT310 CON PIOLO INTERNO</p>
<p>GALFRE' 260</p>	<p>PIASTRE P.C. KRONE mm 356- mm 377</p>	<p>PIASTRA P.C. SIP 185 (CORTA)</p>

Cod.	Descrizione prodotto
23340	PIASTRA P.C. BELLON 170
23350	PIASTRA P.C. BELLON 190
23352	PIASTRA P.C. BELLON 210
23353	PIASTRA P.C. BELLON 135
23355	PIASTRA P.C. CLAAS 1° TIPO
23357	PIASTRA P.C. CLAAS 2° TIPO SENZA PERNO CENTRALE
23360	PIASTRA P.C. CLAAS 2° TIPO con perno
23365	PIASTRA P.C. CLAAS 3° TIPO (210)
23367	PIASTRA P.C. CLAAS CORTA CON PIEGA
23370	PIASTRA P.C. FAHR KM 22 - FORT F8
23374	PIASTRA P.C. FAHR KM 20 (0658.0109)
23380	PIASTRA P.C. FAHR - P.Z. T. VECCHIO
23390	PIASTRA P.C. FAHR ULTIMO TIPO (PER KM 217-219)
23395	PIASTRA P.C. FELLA 1° TIPO
23396	PIASTRA P.C. FELLA 2° TIPO
23400	PIASTRA P.C. GALFRÈ 165
23410	PIASTRA P.C. GALFRÈ 185
23415	PIASTRA P.C. GALFRÈ' 260 L.
23525	PIASTRA P.C. SIP 185 (CORTA)

Cod.	Descrizione prodotto
23417	PIASTRA P.C. KRONE mm 377 GR23046.5
23418	PIASTRA P.C. KRONE mm 356 GR20036169.0
23420	PIASTRA P.C. LINCE
23430	PIASTRA P.C. MARANGON 165
23435	PIASTRA P.C. MARANGON 2° TIPO (DISCHETTI)
23440	PIASTRA P.C. MORRA 1° TIPO
23450	PIASTRA P.C. MORRA 2° TIPO
23455	PIASTRA P.C. NIEMEYER 165
23460	PIASTRA P.C. NIEMEYER 570.441
23470	PIASTRA P.C. P.Z. CORTA 185
23480	PIASTRA P.C. P.Z. DOPPIA CORTA
23490	PIASTRA P.C. P.Z. DOPPIA LUNGA PZ87 135
23500	PIASTRA P.C. P.Z. LUNGA 165
23502	PIASTRA P.C. P.Z. MEDIA 210
23505	PIASTRA P.C. PÖTTINGER LUNGA
23507	PIASTRA P.C. PÖTTINGER CAT 310 (PIOLO INTERNO)
23510	PIASTRA P.C. RASSPE
23520	PREMILAMA RASSPE
23535	BULLONE SPECIALE TTQST M 14x35 PER PIASTRE P.C. PZ 185

## FALCIATRICI ROTATIVE (DISCHI FOLLE)

Cod.	Descrizione prodotto	
23540	DISCO FOLLE AMA 6 FORI mm 760	
23559	DISCO FOLLE B.C.S. 4-5 Ø mm 390x290	
23560	DISCO FOLLE BELLON 135	
23570	DISCO FOLLE BELLON 170	
23580	DISCO FOLLE BELLON 190	
23585	DISCO FOLLE CLAAS 165	
23586	DISCO FOLLE CLAAS 185	
23590	DISCO FOLLE FAHR 135 KM 20 mm 610	
23600	DISCO FOLLE FAHR 165 KM 22 mm 770	
23610	DISCO FOLLE FAHR 185 KM 24 mm 880	
23620	PIATTELLO FAHR KM 24 mm 390	
23625	DISCO FOLLE FAHR KM 25 mm 1000	
23630	DISCO FOLLE FAHR 217	
23635	DISCO FOLLE FAHR 219	
23640	PIATTELLO FAHR 217 - 219	
23830	VITE TCE 12x25 ZN (PER DISCHI FOLLE)	
23835	VITE TCE 12x30 ZN (PER DISCHI FOLLE)	

Cod.	Descrizione prodotto	
23647	DISCO FOLLE FELLA 165	
23648	DISCO FOLLE FELLA 185	
23649	PIATTELLO FELLA 165- 185 Ø 550	
23650	DISCO FOLLE FORT F 8 mm 770	
23660	DISCO FOLLE FORT F 9 mm 875	
23665	DISCO FOLLE GALFRÈ 135 mm 630 4 FORI	
23670	DISCO FOLLE GALFRÈ 165 RINFORZ. 4-6 FORI	
23680	DISCO FOLLE GALFRÈ 165	
23685	DISCO FOLLE GALFRÈ 185 RINFORZ. 4 FORI	
23700	DISCO FOLLE KRONE RECUPERO MOZZO mm 630	
23710	DISCO FOLLE KRONE NORMALE mm 650	
23730	DISCO FOLLE LINCE ROTOLYNX 135 mm 610	
23740	DISCO FOLLE LINCE ROTOLYNX 165 mm 760	
23750	DISCO FOLLE MARANGON 135 mm 610	
23760	DISCO FOLLE MARANGON 165 mm 760	
23766	DISCO FOLLE MARANGON 192 mm 910	
23770	DISCO FOLLE MORRA 165 mm 760	
23780	DISCO FOLLE MORRA 185	

# FALCIATRICI ROTATIVE (DISCHI FOLLE TRAINO-TAMBURI-VARIE)

Cod.	Descrizione prodotto	
23800	DISCO FOLLE P.Z. 135 mm 585	
23810	DISCO FOLLE P.Z. 165 mm 735	
23820	DISCO FOLLE P.Z. 185 mm 865	
23825	MOZZO TORNITO PER DISCO FOLLE PZ 165	
23826	ALBERO VERTICALE PER PZ 165	
23827	CUSCINETTO SUPERIORE PER MOZZO PZ 165	
23828	CUSCINETTO INFERIORE PER MOZZO PZ 165	
23836	MOLLA TRAZIONE APERTURA F. R. PZ	

Cod.	Descrizione prodotto		
23840	DISCO TRAINO BELLON 170		
23850	DISCO TRAINO FAHR KM 20		
23860	DISCO TRAINO FAHR KM 22		
23870	DISCO TRAINO FAHR KM 24		
23880	DISCO TRAINO FAHR KM 217		
23885	DISCO TRAINO FAHR KM 219		
23890	DISCO TRAINO FORT F 8		
23900	DISCO TRAINO FORT F 9		
23911	DISCO TRAINO KUHN CENTRALE mm 335		
23912	DISCO TRAINO KUHN LATERALE mm 335		
23920	DISCO TRAINO LINCÉ ROTOLYNX 135		
23930	DISCO TRAINO LINCÉ ROTOLYNX 165		
23940	DISCO TRAINO MARANGON 165		
23945	DISCO TRAINO MARANGON 190		
23950	DISCO TRAINO MORRA 165		

Cod.	Descrizione prodotto	
23980	DISCO TRAINO P.Z. 165 CON TAMBURO	
23990	DISCO TRAINO P.Z. 185	
23995	DISCO PORTADISCO FAHR KM 22	
23996	DISCHETTO COPRITAMBURO PZ 185 - PZ 185	
24000	TAMBURO FALC. ROT. FAHR 165 KM 22	
24010	TAMBURO FALC. ROT. FORT F8 165	
24015	TAMBURO FALC. ROT. GALFRÈ	
24016	TAMBURO FALC. ROT. LYNX 165	
24020	TAMBURO FALC. ROT. MORRA 165	
24025	TAMBURO FALC. ROT. PZ 185	
24028	PIASTRINA PER TAMBURI PZ 165	
24029	PIASTRINA PER TAMBURI PZ 185	
24030	TELO UNIVERSALE RINFORZATO CON OCCHIELLI	

Cod.	Descrizione prodotto	
23970	DISCO TRAINO P.Z. 135 CON TAMBURO	

# COLTELLI PER FALCIATRICI ROTATIVE (1)

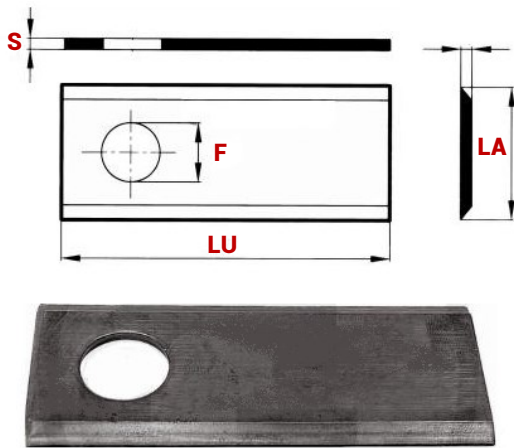

## FORMA DIRITTA

misure in mm

CODICE	V. & V.	LU	LA	S	F	ADATTABILITA' MARCHE
26890	85D	85	40	4	19	Fella
26895	90D	90	40	3	19	Niemeyer-Krone-Claas-PZ
26900	96D	96	40	3	19	Rasspe-Claas-Fahr-Fella
26905	97D	97	50	4	19	J F (Freudenthal)
26910	98D	98	40	3	19	Fort-Morra-Galfré-AMA
26920	108D	108	46	3	21	Bellon-Marangon-Galfré-Seko
26925	108D2	108	47	3	19	Galfré nuovo tipo

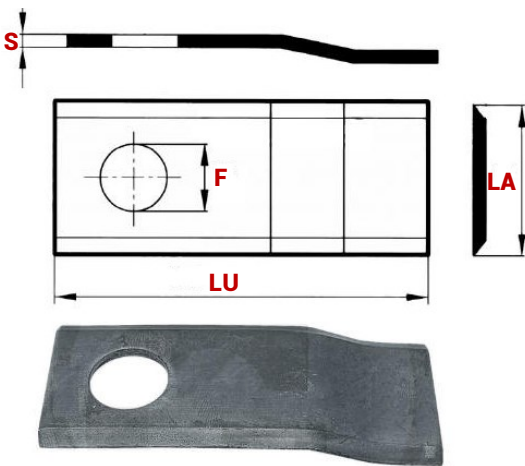

## FORMA PIEGATA (in fondo)

misure in mm

CODICE	V. & V.	LU	LA	S	F	ADATTABILITA' MARCHE
26930	90P	90	40	3	19	Lince
26940	96P	96	40	3	19	Fahr
26950	98P	98	40	3	19	Fort-Morra-Marangon-AMA
26960	108P	108	46	3	21	Bellon - Galfré
26965	108P2	108	47	3	19	Galfré nuovo tipo
26968	118P	118	50	4	21	Bellon
26970	119P	119	50	4	21	Pöttinger piega forte

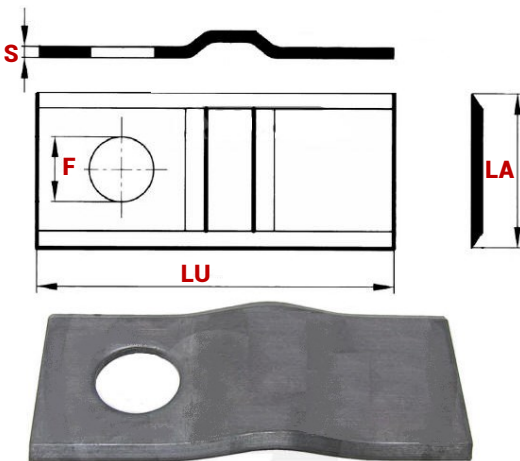

## FORMA CURVATA (in mezzo)

misure in mm

CODICE	V. & V.	LU	LA	S	F	ADATTABILITA' MARCHE
26980	105C-PZ	105	46	3	21	PZ Zweegers
26990	108C	108	46	3	21	Marangon-PZ

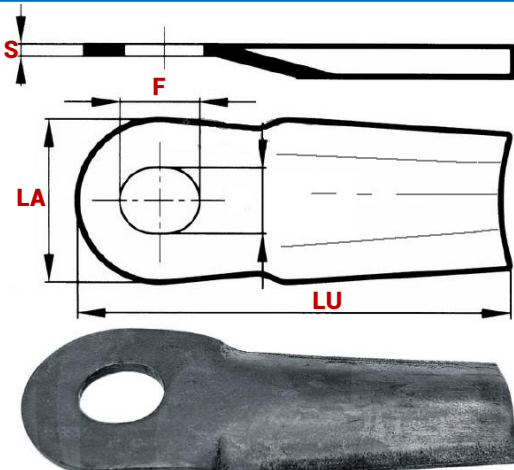

## FORMA BOMBATA

misure in mm

CODICE	V. & V.	LU	LA	S	F	ADATTABILITA' MARCHE
26993	113B	113	40/50	4	18,5x20,5	Kuhn-John Deere
26995	116B	116	40/50	4	21x23	Gaspardo-Comer-Taarup
27000	128B	128	35/50	4	21x23	Kuhn-Taarup
27007	132B	132	50	4	20,5x22,8	Taarup-Kverneland

Attenzione: i nomi delle marche produttrici delle attrezzature, dei modelli di macchine ed eventuali codici originali dei coltelli sono riportati a puro titolo di riferimento, e non vogliono intendere che i prodotti da noi venduti siano originali. I nostri coltelli sono di produzione "Frielinghaus" "Rasspe" "Stella"

# COLTELLI PER FALCIATRICI ROTATIVE (2)

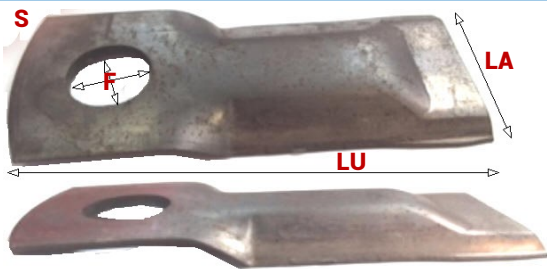

## FORMA BOMBATA/DIRITTA misure in mm

CODICE	V. & V.	LU	LA	S	F	ADATTABILITA' MARCHE
27003	116B+D	116	48	4	21x23	Krone (ad esaurimento)
27004	117B+D	117	55	4	19	Krone
27005	131B+D	131	50	4	20,5x23	Taarup-Kverneland

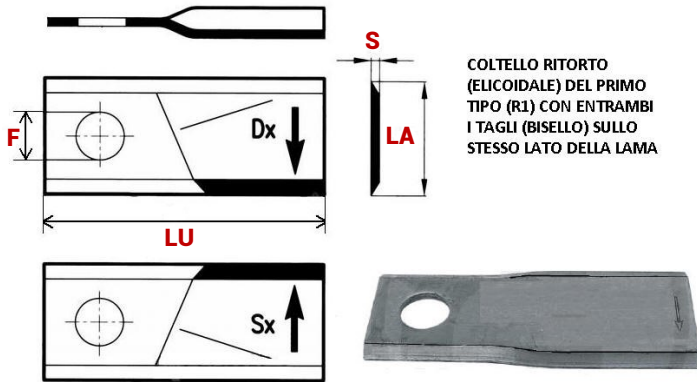

## FORMA RITORTA (elicoidale)

con taglio sulla stessa faccia misure in mm

CODICE	V. & V.	LU	LA	S	F	ADATTABILITA' MARCHE
27010	93R1	93	40	3	16	Kuhn-Pöttinger-PZ
27020	95R1	95	45	3,5	16	Kuhn
27030	98R1	98	45	3,5	16,25	Fort f.c.
27033	107B R1	107	45	4	21	Bellon prima versione
27035	107R1 F	107	40	4	16,25	Fort - Morra f. c.
27040	107R1 K	107	45	4	18	Kuhn
27060	123R1	123	45	4	18	Kuhn
27070	126R1	126	48	4	21x23	Kuhn - Taarup

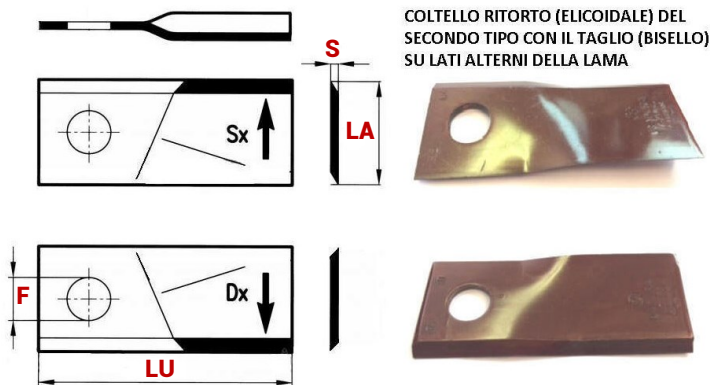

## FORMA RITORTA (elicoidale)

con taglio alterno sulle due facce misure in mm

CODICE	V. & V.	LU	LA	S	F	ADATTABILITA' MARCHE
27075	93 R2	93	49	3	19	PZ Zweegers (TF)
27076	93Mo R2	93	49	3	23	Moertl
27077	94B R2	94	48	4	19	BCS 2° tipo
27079	94 K R2	94	40	3	19	Krone
27081	97 R2	97	47	4	19	J F Freundahl
27083	98 R2	98	48	4	19	Fella- BCS 3° tipo
27085	100 B R2	100	40	3	19	BCS 1° tipo
27087	100 C R2	100	48	3	19	Claas
27089	100 Ma R2	100	45	4	21	Marangon 100 MEL-MER
27091	100 Mo R2	100	48	3	23	Mörtl
27093	100 P R2	100	48	4	21	Pöttinger
27095	100 P R2 SP	100	48	4	21	Pöttinger (piega diversa)
27096	102F R2	102	48	4	19	Fella
27097	105C R2	105	48	4	19	Claas
27098	105C R2	105	48	3	19	Claas
27099	105 M R2	105	45	4	21	Marangon 105 MEL-MER
27101	106 R2	106	48	4	19	Fella
27103	107 B R2	107	45	4	21	Bellon nuovo
27105	107 MG R2	107	45	3	21	Marangon-Galfrè f. c.
27107	107 V R2	107	50	4,3	18,5	Vicon-Pöttinger
27109	108 G R2	108	40	4	21	Galfrè 108 stretto
27111	108 P R2 a	108	47	4	19	Pöttinger 108 1° tipo
27113	108 P R2 b	108	47	4	21	Pöttinger 108 2° tipo
27115	110 M R2	110	45	4	21	Marangon 110 MEL-MER
27117	112 F R2	112	47	4	19	Fella-Krone-Stoll
27119	112 P R2	112	48	4	21	Pöttinger
27121	115 R2	115	47	4	19	Claas
27123	118 R2	118	47	4	19	Fella
27125	120 P R2	120	47	4	21	Pöttinger f. cond.
27127	120 V R2	120	48	4	18,5	Vicon
27129	129 R2	129	48	4	21	Marangon 129 MEL-MER



**ampia disponibilità di magazzino**

**preventivi su richiesta**



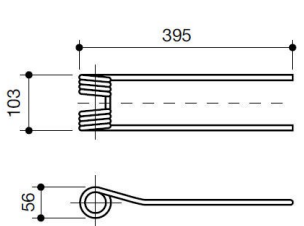
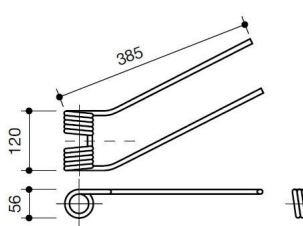
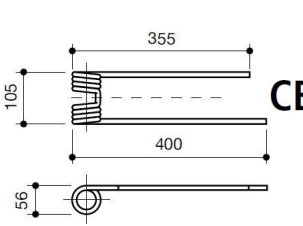
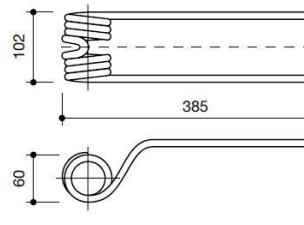
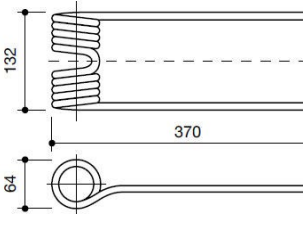
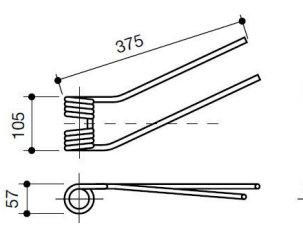
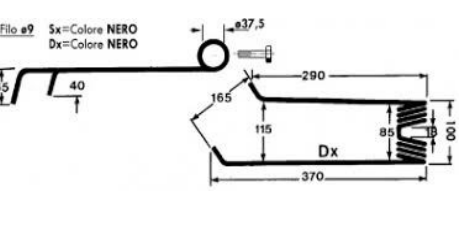
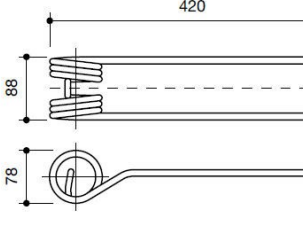
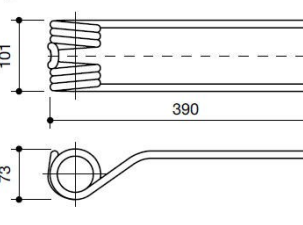
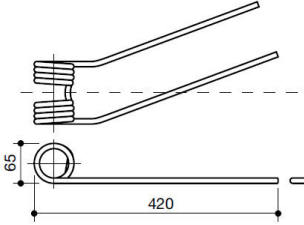
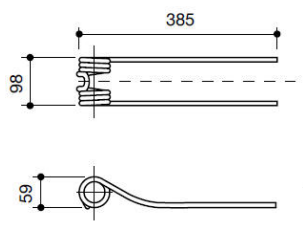
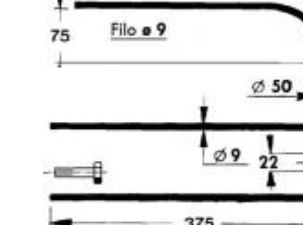
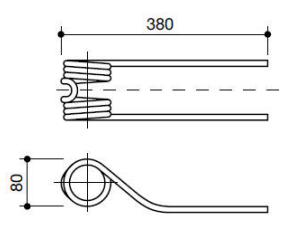
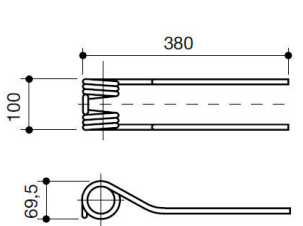
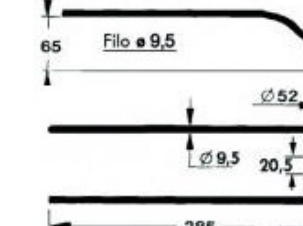
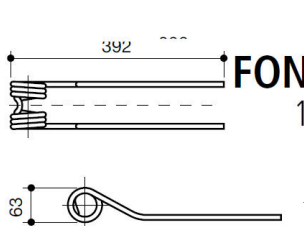
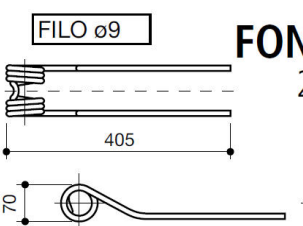
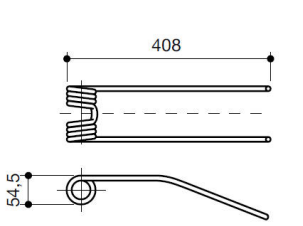

# DENTI A MOLLA PER GIRELLI

 <p><b>BCS</b></p> <p>FILO <math>\varnothing 9</math></p>	 <p><b>BAUTZ destro</b></p> <p>FILO <math>\varnothing 9</math></p>	 <p><b>CECCATO destro</b></p> <p>FILO <math>\varnothing 9</math></p>
<p>Cod. 24520 <b>GIRELLO BCS MAINARDI - CECCATO 2° TIPO</b></p>	<p>Cod. 24530 <b>GIRELLO BAUTZ</b></p>	<p>Cod. 24560 <b>GIRELLO CECCATO 3° TIPO</b></p>
 <p><b>GIRELLO CLAAS F. mm 9,5</b></p> <p>FILO <math>\varnothing 9,5</math></p>	 <p><b>GIRELLO CLAAS VOLTO</b></p> <p>FILO <math>\varnothing 9,5</math></p>	 <p><b>COMA destro</b></p> <p>FILO <math>\varnothing 9</math></p>
<p>Cod. 24562 <b>GIRELLO CLAAS F. mm 9,5</b></p>	<p>Cod. 24563 <b>GIRELLO CLAAS VOLTO</b></p>	<p>Cod. 24570 <b>GIRELLO CO.M.A. - CECCATO CBR 1° TIPO</b></p>
 <p><b>GIRELLO CONTINENTAL</b></p> <p>FILO <math>\varnothing 9</math></p> <p>Sx=Colore NERO Dx=Colore NERO</p>	 <p><b>GIRELLO DA ROS - MOLON 1° TIPO - OLIVI 1° T.</b></p> <p>FILO <math>\varnothing 9</math></p>	 <p><b>GIRELLO DA ROS ULTIMO TIPO ATTACCO</b></p> <p>FILO <math>\varnothing 10</math></p>
<p>Cod. <b>GIRELLO CONTINENTAL</b></p>	<p>Cod. <b>GIRELLO DA ROS - MOLON 1° TIPO - OLIVI 1° T.</b></p>	<p>Cod. <b>GIRELLO DA ROS ULTIMO TIPO ATTACCO</b></p>
 <p><b>F.C.R. FILO mm 9,5</b></p> <p>FILO <math>\varnothing 9,5</math></p> <p><b>FCR destro</b></p>	 <p><b>GIRELLO FAHR T.V. d. foro 40</b></p> <p>FILO <math>\varnothing 9</math></p>	 <p><b>GIRELLO FAHR 2° TIPO - VICON d foro 50 - filo</b></p> <p>FILO <math>\varnothing 9</math></p>
<p>Cod. <b>GIRELLO F.C.R. FILO mm 9,5</b></p>	<p>Cod. <b>GIRELLO FAHR T.V. d. foro 40</b></p>	<p>Cod. <b>GIRELLO FAHR 2° TIPO - VICON d foro 50 - filo</b></p>
 <p><b>GIRELLO FAHR 4° TIPO - VICON d foro 60 - filo</b></p> <p>FILO <math>\varnothing 10</math></p>	 <p><b>FELLA 4° TIPO</b></p> <p>FILO <math>\varnothing 9,5</math></p>	 <p><b>GIRELLO FELLA 3° TIPO FILO mm 9,50</b></p> <p>FILO <math>\varnothing 9,5</math></p>
<p>Cod. <b>GIRELLO FAHR 4° TIPO - VICON d foro 60 - filo</b></p>	<p>Cod. <b>GIRELLO FELLA 4° TIPO</b></p>	<p>Cod. <b>GIRELLO FELLA 3° TIPO FILO mm 9,50</b></p>
 <p><b>FONTANESI 1° tipo</b></p> <p>FILO <math>\varnothing 9</math></p>	 <p><b>FONTANESI 2° tipo</b></p> <p>FILO <math>\varnothing 9</math></p>	 <p><b>FORT</b></p> <p>FILO <math>\varnothing 9</math></p>
<p>Cod. 24630 <b>GIRELLO FONTANESI T.V.</b></p>	<p>Cod. 24640 <b>GIRELLO FONTANESI TIPO NUOVO</b></p>	<p>Cod. 24650 <b>GIRELLO FORT</b></p>

**N.B. ALCUNI MODELLI DI GIRELLO RICHIEDONO DENTE DESTRO E DENTE SINISTRO: IL PRESENTE CATALOGO VISUALIZZA IL DESTRO**

# DENTI A MOLLA PER GIRELLI

<p><b>GALFRÈ</b> destro</p>	<p><b>GALFRE'</b> 87</p>	<p><b>GALFRE'</b> 88 1° tipo</p>
<p>Cod. 24660 GIRELLO GALFRE T.V. (Dx-Sx) - BITTANTE</p>	<p>Cod. 24670 GIRELLO GALFRE 87 ATTACCO 90°</p>	<p>Cod. 24680 GIRELLO GALFRE 88 ATTACCO ALTO</p>
<p><b>GALFRE'</b> 88 2° tipo</p>	<p><b>GALFRE' 92</b></p>	<p><b>GALFRE'</b> GTS</p>
<p>Cod. GIRELLO GALFRE 88 LUNGO ATTACCO SOTTO</p>	<p>Cod. GIRELLO GALFRE 92 (MOD. ATTUALE) MOLON</p>	<p>Cod. GIRELLO GALFRE GTS</p>
<p><b>ITALOSVIZZERA</b></p> <p><b>ITALOSVIZZERA</b></p>	<p><b>KRONE</b> destro</p>	<p><b>KUHN</b></p>
<p>Cod. 24720 GIRELLO ITALOSVIZZERA</p>	<p>Cod. 24725 GIRELLO KRONE Dx-Sx</p>	<p>Cod. 24730 GIRELLO KUHN TIPO NUOVO (40035)</p>
<p><b>KUHN</b> DESTRO</p>	<p><b>LELY</b> DESTRO</p>	<p><b>LINCE</b> destro</p>
<p>Cod. 24735 GIRELLO KUHN TIPO NUOVO Dx-Sx</p>	<p>Cod. 24750 GIRELLO LELY 40049-50</p>	<p>Cod. 24760 GIRELLO LINCE FORO mm 44</p>
<p><b>LINCE</b> TIPO NUOVO</p>	<p><b>LINCE</b> destro</p>	<p><b>MARANGON</b></p>
<p>Cod. 24770 GIRELLO LINCE TIPO NUOVO</p>	<p>Cod. 24775 GIRELLO LINCE-FORT Dx-Sx FORO mm 51</p>	<p>Cod. 24780 GIRELLO MARANGON</p>
<p><b>MORRA - FAHR - FORT T. N.</b></p>	<p><b>NIEMEYER</b></p>	<p><b>POTTINGER TIPO NUOVO</b></p>
<p>Cod. 24810 GIRELLO MORRA - FAHR - FORT T. N. filo mm 10</p>	<p>Cod. 24830 GIRELLO NIEMEYER</p>	<p>Cod. 24845 GIRELLO POTTINGER TIPO NUOVO</p>

N.B. ALCUNI MODELLI DI GIRELLO RICHIEDONO DENTE DESTRO E DENTE SINISTRO: IL PRESENTE CATALOGO VISUALIZZA IL DESTRO

# DENTI A MOLLA PER GIRELLI

<p><b>POTTINGER destro</b></p>	<p><b>PZ STRELA</b></p>	<p><b>GIRELLO P.Z. FANEX</b></p>
<p>Cod. <b>GIRELLO POTTINGER ULTIMO TIPO DX+SX</b></p>	<p>Cod. <b>GIRELLO P.Z. 106-107-110-111 STRELA</b></p>	<p>Cod. <b>GIRELLO P.Z. FANEX</b></p>
<p><b>PZ FANEX destro</b></p>	<p><b>PZ FLEVO</b></p>	<p><b>GIRELLO P.Z. FANEX DX-SX</b></p>
<p>Cod. <b>GIRELLO P.Z. FANEX DX-SX</b></p>	<p>Cod. <b>GIRELLO P.Z. FLEVO 40076-7-8-9</b></p>	<p>Cod. <b>GIRELLO TIGRE</b></p>
<p><b>SIP destro</b></p>	<p><b>GIRELLO SLAM T.V.</b></p>	<p><b>GIRELLO SLAM TIPO NUOVO</b></p>
<p>Cod. <b>GIRELLO SIP TIPO NUOVO DX-SX</b></p>	<p>Cod. <b>GIRELLO SLAM T.V.</b></p>	<p>Cod. <b>GIRELLO SLAM TIPO NUOVO</b></p>
<p><b>GIRELLO STOLL</b></p>	<p><b>N.B. ALCUNI MODELLI DI GIRELLO RICHIEDONO DENTE DESTRO E DENTE SINISTRO: IL PRESENTE CATALOGO VISUALIZZA IL DESTRO</b></p> <h2 style="text-align: center;">RUOTE PER GIRELLI E GIRO-ANDANATORI</h2>	
<p>Cod. <b>GIRELLO STOLL</b></p>		

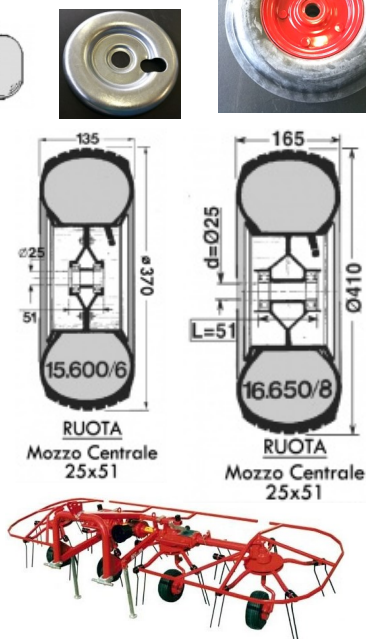
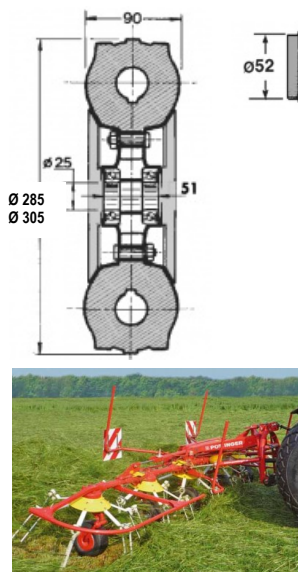

Cod. 25357	RUOTA SEMIPIENA 285x90 SMONTABILE (GIRELLI T. V.)
Cod. 25358	COPPIA COPRICERCHI PER 15.600/6" (67189A)
Cod. 25359	COPPIA COPRICERCHI PER 16X6.50/8" (67195)
Cod. 25360	COPPIA COPRICERCHI PAR 15.600/6" Ø 145 (67189)
Cod. 25361	COPPIA COPRICERCHI PER RUOTA 285x90
Cod. 25362	RUOTA SEMIPIENA 305x90 NON SMONTABILE (GALFRE)
Cod. 25363	RUOTA PNEUMATICA 15.600/6" MOZZO 25x51 CENTRALE
Cod. 25364	RUOTA PNEUMATICA 15.600/6" MOZZO 25x51 LATERALE
Cod. 25365	COPERTURA E CAMERA PER RUOTA 15.600/6" 6PR RIGATA
Cod. 25366	CAMERA D'ARIA PER RUOTA 15.600/6" 6PR RIGATA
Cod. 25367	RUOTA PNEUMATICA 16x6.50/8" 6PR RIGATA MOZZO 25X64
Cod. 25368	RUOTA PNEUMATICA 16x6.50/8" 6PR RIGATA MOZZO 25X51
Cod. 25369	COPERTURA E CAMERA PER RUOTA 16x6.50/8" RIGATA
Cod. 25370	CAMERA D'ARIA PER RUOTA 16x6.50/8"

# DENTI A MOLLA PER GIRO - ANDANATORI

<p>Cod. <b>GIRO-AND. BCS SECONDO TIPO LUNGO</b></p>	<p>Cod. <b>GIRO-AND. BCS PRIMO TIPO CORTO</b></p>	<p>Cod. <b>GIRO-AND. BORELLO CORTO mm 525</b></p>
<p>Cod. <b>24940 GIRO-AND. BORELLO LUNGO mm 630 Sx- Dx</b></p>	<p>Cod. <b>24948 GIRO-AND. CECCATO - F.C.R. GIRORAMI CON PIEGHE</b></p>	<p>Cod. <b>24950 GIRO-AND. CECCATO - F.C.R. - DA ROS 1° TIPO</b></p>
<p>Cod. <b>GIRO-AND. CIMAC 30009</b></p>	<p>Cod. <b>GIRO-AND. DA ROS - FIORINI mm 550</b></p>	<p>Cod. <b>GIRO-AND. CO. M. A. - MORRA T.V.</b></p>
<p>Cod. <b>GIRO-AND. CORMA</b></p>	<p>Cod. <b>GIRO-AND. FAHR CORTO mm 515</b></p>	<p>Cod. <b>GIRO-AND. FAHR KS 1,50 - 1,70 CON PIEGHE</b></p>
<p>Cod. <b>25000 GIRO-AND. FAHR TIPO NUOVO KS83 - KS85</b></p>	<p>Cod. <b>25003 GIRO-AND. FAHR TIPO NUOVO KS83 - KS85 CON PIEGHE</b></p>	<p>Cod. <b>25005 GIRO-AND. FAHR-CLAAS-BAUTZ ULTIMO TIPO mm 600</b></p>
<p>Cod. <b>25010 GIRO-AND. FELLA DESTRO mm 560</b></p>	<p>Cod. <b>25020 GIRO-AND. FELLA</b></p>	<p>Cod. <b>25025 GIRO-AND. FELLA ATTACCO SPORGENTE T. N.</b></p>

**N.B. ALCUNI MODELLI DI GIRO-ANDANATORE RICHIEDONO DENTE DESTRO E DENTE SINISTRO: IL PRESENTE CATALOGO VISUALIZZA IL DESTRO**

# DENTI A MOLLA PER GIRO - ANDANATORI

<p>Cod. 25040 GIRO-AND. FONTANESI CORTO mm 520</p>	<p>Cod. 25050 GIRO-AND. FONTANESI LUNGO mm 585</p>	<p>Cod. 25055 GIRO-AND. FONTANESI ULTIMO TIPO CON PIEGHE</p>
<p>Cod. GIRO-AND. FORT 2° TIPO mm 8x575</p>	<p>Cod. GIRO-AND. FORT 4° TIPO mm 9x610</p>	<p>Cod. GIRO-AND. GALFRE ATT.LUNGO mm 590</p>
<p>Cod. 25070 GIRO-AND. GALFRE ATT. LUNGO Sx mm 640</p>	<p>Cod. 25080 GIRO-AND. GALFRE DIRITTO mm 580</p>	<p>Cod. 25100 GIRO-AND. GALFRE 92 NUOVO ATT. INFER. mm 605</p>
<p>Cod. 25105 GIRO-AND. GALFRE 2000 NUOVO ATT. SUPER. mm 605</p>	<p>Cod. 25110 GIRO-AND. GALFRE NUOVO ATT. SUPER. LUNGO (G. 2000)</p>	<p>Cod. 25115 GIRO-AND. GALFRE PIEGATO AG320</p>
<p>Cod. 25125 GIRO-AND. KRONE ULTIMO TIPO PIEGATO E DIRITTO</p>	<p>Cod. 25126 GIRO-AND. KRONE 2690420</p>	<p>Cod. 25127 GIRO-AND. KRONE SWADRO</p>
<p>Cod. GIRO-AND. KUHN GA 381 (30035)</p>	<p>Cod. GIRO-AND. KUHN mm 10 GRS25 N (30034)</p>	<p>Cod. GIRO-AND. KUHN mm 8,5 (30033)</p>

# DENTI A MOLLA PER GIRO - ANDANATORI

<p>Cod. <b>GIRO-AND. KUHN LUNGO NUOVO GA350</b></p>	<p>Cod. <b>GIRO-AND. LINCE T.V.</b></p>	<p>Cod. <b>GIRO-AND. MOLON LUNGO mm 630</b></p>
<p>Cod. <b>25200 GIRO-AND. MORRA LUNGO mm 595</b></p>	<p>Cod. <b>25204 GIRO-AND. NIEMEYER TWIN (DENTI ASIMMETRICI)</b></p>	<p>Cod. <b>25206 GIRO-AND. NIEMEYER 2° TIPO 30044</b></p>
<p>Cod. <b>GIRO-AND. OLIVI mm 8,5x560</b></p>	<p>Cod. <b>GIRO-AND. POTTINGER Dx mm 495</b></p>	<p>Cod. <b>GIRO-AND. POTTINGER Dx mm 510</b></p>
<p>Cod. <b>GIRO-AND. POTTINGER SX mm 510</b></p>	<p>Cod. <b>GIRO-AND. POTTINGER mm 555</b></p>	<p>Cod. <b>GIRO-AND. REPOSSI 3° TIPO FILO mm 8,5</b></p>
<p>Cod. <b>GIRO-AND. REPOSSI 5° TIPO</b></p>	<p>Cod. <b>GIRO-AND. SUPERMIXER mm 530</b></p>	<p>Cod. <b>GIRO-AND. SIP NUOVO</b></p>
<p>Cod. <b>GIRO-AND. SLAM Dx</b></p>	<p>Cod. <b>GIRO-AND. SLAM LUNGO</b></p>	<p>Cod. <b>GIRO-AND. SLAM CON PIEGHE Ø GRANDE T. N.</b></p>

## DENTI A MOLLA PER GIRO - ANDANATORI

<p><b>FILO ø8,5</b> <b>SLAM GIRORAMI</b> sinistro</p>	<p><b>FILO ø8,5</b> <b>SLAM GIRORAMI</b> sinistro</p>	<p><b>FILO ø9</b></p>
<p>Cod. 25280 <b>GIRO-AND. SLAM Sx</b></p>	<p>Cod. 25290 <b>GIRO-AND. STOLL - NEW HOLLAND - COMBIN. MARANGON</b></p>	<p>Cod. 25300 <b>GIRO-AND. STOLL F. GRANDE mm 540</b></p>
<p><b>FILO ø8,5</b></p>	<p><b>FILO ø9</b></p>	<p><b>FILO ø9 UNI=Colore ROSSO</b></p>
<p>Cod. 25310 <b>GIRO-AND. STOLL F. PICCOLO mm 540 Dx</b></p>	<p>Cod. 25315 <b>GIRO-AND. STOLL DIRITTO</b></p>	<p>Cod. 25316 <b>GIRO-AND. STOLL DIRITTO LUNGO R300/8 (mm 625)</b></p>

N.B. ALCUNI MODELLI DI GIRO-ANDANATORE RICHIEDONO DENTE DESTRO E DENTE SINISTRO: IL PRESENTE CATALOGO VISUALIZZA IL DESTRO

## DENTI A MOLLA PER RASTRELLIERE

<p><b>FILO ø5,5</b></p>	<p><b>FILO ø6</b></p>	<p><b>FILO ø6</b></p>
<p>Cod. <b>RASTRELLIERA BCS mm 520 - 2 P.</b></p>	<p>Cod. <b>RASTRELLIERA CLAAS mm 570 PIEGA BASSA</b></p>	<p>Cod. <b>RASTRELLIERA DA ROS - FCR</b></p>
<p><b>FILO ø6</b></p>	<p><b>FILO ø6</b></p>	<p><b>FILO ø6</b></p>
<p>Cod. <b>RASTRELLIERA GALFRE mm 700</b></p>	<p>Cod. <b>RASTRELLIERA REPOSSI mm 540</b></p>	<p>Cod. <b>RASTRELLIERA SLAM mm 610 PIEGA ALTA</b></p>

## DENTI A MOLLA PER USI DIVERSI

<p><b>FILO ø5,5</b></p>	<p><b>FILO ø6,5</b></p>	<p><b>FILO ø7,5</b></p>
<p><b>FILO ø5,5</b></p>	<p><b>FILO ø5,5</b></p>	<p><b>FILO ø8</b></p>
<p>Cod. 25670 <b>FALCIAONDIZ. NEW HOLLAND</b></p>	<p>Cod. 25680 <b>MIETTREBBIA NEW HOLLAND</b></p>	<p>Cod. 25640 <b>SROTOLATORE BICIEFFE mm 7</b></p>

# DENTI A MOLLA PER AUTOCARICANTI

<p><b>FILO ø5,5</b></p>	<p><b>FILO ø6</b></p>	<p><b>FILO ø5</b></p>
<p><b>Cod. 25390</b> AUTOCARICANTE BERNI EUROPA FILO 5,5</p>	<p><b>Cod. 25400</b> AUTOCARICANTE BERNI EUROPA FILO 6</p>	<p><b>Cod. 25410</b> AUTOCARICANTE DBD-SANTINI-GHIOZZI-FORT-MARANGON T.N. 2° TIPO</p>
<p><b>FILO ø5</b></p>	<p><b>FILO ø4,8</b></p>	<p><b>FILO ø5</b></p>
<p><b>Cod. 25420</b> AUTOCARICANTE DECHENTREITER</p>	<p><b>Cod. 25430</b> AUTOCARICANTE FAHR ATT. ALTO</p>	<p><b>Cod. 25440</b> AUTOCARICANTE ITALOSVIZZERA</p>
<p><b>FILO ø5,5</b></p>	<p><b>FILO ø5</b></p>	<p><b>FILO ø5</b></p>
<p><b>Cod. 25450</b> AUTOCARICANTE KEMPER - KRONE</p>	<p><b>Cod. 25455</b> AUTOCARICANTE KRONE FORAGGERO</p>	<p><b>Cod. 25460</b> AUTOCARICANTE KODEL &amp; BAUM (KOLA)</p>
<p><b>FILO ø5</b></p>	<p><b>FILO ø6</b></p>	<p><b>FILO ø5</b></p>
<p><b>Cod. 25470</b> AUTOCARICANTE LUXOR</p>	<p><b>Cod. 25480</b> AUTOCARICANTE MARANGON T.V. - 1° TIPO</p>	<p><b>Cod. 25490</b> AUTOCARICANTE MENGELE LW 157</p>
<p><b>FILO ø5</b></p>	<p><b>FILO ø5</b></p>	<p><b>FILO ø6</b></p>
<p><b>Cod. 25495</b> AUTOCARICANTE MENGELE LW 157 LUNGO</p>	<p><b>Cod. 25500</b> AUTOCARICANTE MENGELE PICCOLO</p>	<p><b>Cod. 25510</b> AUTOCARICANTE OMAS mm 6</p>
<p><b>FILO ø5,3</b></p>	<p><b>FILO ø5</b></p>	<p><b>FILO ø5,5</b></p>
<p><b>Cod. 25520</b> AUTOCARICANTE PÖTTINGER</p>	<p><b>Cod. 25530</b> AUTOCARICANTE STEYR</p>	<p><b>Cod. 25540</b> AUTOCARICANTE VESUVIO</p>



# DENTI A MOLLA PER PRESSE (BALLE QUADRE)

<p>Cod. <b>PRESSA ABBRIATA LARGA</b></p>	<p>Cod. <b>PRESSA AMA 902042 T. NUOVO</b></p>	<p>Cod. <b>PRESSA AMA MEDIA 202011</b></p>
<p>Cod. <b>PRESSA AMA SPAGNA</b></p>	<p>Cod. <b>PRESSA BAMFORD BS 2530</b></p>	<p>Cod. <b>PRESSA BAMFORD STRETTA</b></p>
<p>Cod. <b>PRESSA BAUTZ COMPACT</b></p>	<p>Cod. <b>PRESSA CASE F60546</b></p>	<p>Cod. <b>PRESSA CLAAS foro 8</b></p>
<p>Cod. <b>PRESSA CLAAS foro 8 FILO mm 6</b></p>	<p>Cod. <b>PRESSA CLAAS foro 10</b></p>	<p>Cod. <b>PRESSA CORMICK B 47 (LARGA)</b></p>
<p>Cod. <b>PRESSA CORMICK 420 (STRETTA)</b></p>	<p>Cod. <b>PRESSA GALLIGNANI 7000 ATT. LUNGO</b></p>	<p>Cod. <b>PRESSA GALLIGNANI 8876210 LARGA</b></p>
<p>Cod. <b>PRESSA GALLIGNANI 8876210 L. PES.</b></p>	<p>Cod. <b>PRESSA HESSTON ATTACCO ANGOL.</b></p>	<p>Cod. <b>PRESSA HESSTON ATTACCO DIRITTO</b></p>

# DENTI A MOLLA PER PRESSE (BALLE QUADRE)

<p>Cod. <b>PRESSA ITALOSVIZZERA LARGA</b></p>	<p>Cod. <b>PRESSA ITALOSVIZZERA STRETTA</b></p>	<p>Cod. <b>PRESSA JOHN DEERE 332-6</b></p>
<p>Cod. <b>PRESSA JOHN DEERE CB 300</b></p>	<p>Cod. <b>PRESSA JOHN DEERE 224</b></p>	<p>Cod. <b>PRESSA LERDA</b></p>
<p>Cod. <b>PRESSA MASSEY FERGUSON LARGA</b></p>	<p>Cod. <b>PRESSA RIVIERRE CASALIS</b></p>	<p>Cod. <b>PRESSA SAIMM 460-480 TIPO NUOVO</b></p>
<p>Cod. <b>PRESSA SAIMM AGRIFULL</b></p>	<p>Cod. <b>PRESSA SAIMM LARGA</b></p>	<p>Cod. <b>PRESSA SAIMM STRETTA</b></p>
<p>Cod. <b>PRESSA SGORBATI LARGA 67-68-69</b></p>	<p>Cod. <b>PRESSA SGORBATI LUNGA 270</b></p>	<p>Cod. <b>PRESSA SGORBATI MEDIA 169-171</b></p>
<p>Cod. <b>PRESSA SGORBATI STRETTA 171</b></p>	<p>Cod. <b>PRESSA WELGER 2 SPIRE</b></p>	<p>Cod. <b>PRESSA WELGER filo 5</b></p>

# DENTI A MOLLA PER ROTOPRESSE (BALLE CILINDRICHE)

<p>Cod. 26080 ROTOPRESSA AMA - SANTINI - FORT 1° TIPO (ATT. ALTO L mm 60)</p>	<p>Cod. 26100 ROTOPRESSA CLAAS FORO mm 10</p>	<p>Cod. 26105 ROTOPRESSA CLAAS VARIANT (BALLE GIGANTI)</p>
<p>Cod. 26110 ROTOPRESSA FERABOLI</p>	<p>Cod. 26115 ROTOPRESSA FERABOLI ATTACCO ALTO "EXTREME"</p>	<p>Cod. 26117 ROTOPRESSA FERABOLI ATTACCO ALTO TIPO LUNGO</p>
<p>Cod. ROTOPRESSA FAHR PICCOLO</p>	<p>Cod. ROTOPRESSA FAHR GRANDE</p>	<p>Cod. ROTOPRESSA GALLIGNANI 2° TIPO FILO mm 6</p>
<p>Cod. ROTOPRESSA GALLIGNANI 3° TIPO DIRITTO</p>	<p>Cod. ROTOPRESSA GALLIGNANI 3° TIPO CON PIEGA</p>	<p>Cod. ROTOPRESSA HESSTON ATTACCO PIEGATO</p>
<p>Cod. 26145 ROTOPRESSA HESSTON 4860-4880 BALLE GIGANTI</p>	<p>Cod. 26146 ROTOPRESSA HESSTON 4600</p>	<p>Cod. 26150 ROTOPRESSA JOHN DEERE 1° TIPO</p>
<p>Cod. ROTOPRESSA JOHN DEERE 2° TIPO</p>	<p>Cod. ROTOPRESSA KRONE 1° TIPO</p>	<p>Cod. ROTOPRESSA KRONE 2° TIPO</p>

# DENTI A MOLLA PER ROTOPRESSE (BALLE CILINDRICHE)

<p>Cod. 26180 ROTOPRESSA KRONE 3° TIPO</p>	<p>Cod. 26190 ROTOPRESSA KRONE 4° TIPO</p>	<p>Cod. 26195 ROTOPRESSA KRONE 5° TIPO</p>
<p>Cod. 26196 ROTOPRESSA KRONE 6° TIPO</p>	<p>Cod. 26197 ROTOPRESSA KRONE 7° TIPO</p>	<p>Cod. 26198 ROTOPRESSA KRONE 8° TIPO</p>
<p>Cod. 26200 ROTOPRESSA LERDA</p>	<p>Cod. 26205 ROTOPRESSA LERDA 3° TIPO</p>	<p>Cod. 26207 ROTOPRESSA FORT 2° T.-MORRA 3° T.-WOLVO (L. mm 64 ATT. ALTO-PIEGHE)</p>
<p>Cod. 26210 ROTOPRESSA NEW HOLLAND ATT. STRETTO</p>	<p>Cod. 26220 ROTOPRESSA SGORBATI ATTACCO 90°</p>	<p>Cod. 26225 ROTOPRESSA SUPERTINO</p>
<p>Cod. 26230 ROTOPRESSA VICON</p>	<p>Cod. 26240 ROTOPRESSA WOLVO - CARRARO - MORRA - OMAS (ATT. ALTO L mm 75) - NORMALE</p>	<p>Cod. 26242 ROTOPRESSA WOLVO-MASCAR U. TIPO LARGA (ATTACCO BASSO L mm 75)</p>
<p>Cod. 26243 ROTOPRESSA WOLVO-MORRA U.T. STRETTA (L mm 64 ATT. BASSO CON PIEGHE) FORT T N</p>	<p>Cod. 26060 MOLLA PRESSAPAGLIA AMA</p>	<p>Cod. 26070 MOLLA PRESSAPAGLIA GALLIGNANI</p>

# DENTI A MOLLA PER RANGHINATORI A PETTINE

<p><b>Cod. 26250</b> RANGHINATORE BCS FORO mm 08</p>	<p><b>Cod. 26270</b> RANGHINATORE CANTONE 1° TIPO</p>	<p><b>Cod. 26280</b> RANGHINATORE CANTONE MAB 4</p>
<p><b>Cod. 26290</b> RANGHINATORE CECCATO CO 63</p>	<p><b>Cod. 26295</b> RANGHINATORE CECCATO TIPO CO PESANTE</p>	<p><b>Cod. 26300</b> RANGHINATORE FONTANESI A QUADRA</p>
<p><b>Cod. 26310</b> RANGHINATORE FONTANESI FORO mm 09</p>	<p><b>Cod. 26320</b> RANGHINATORE FONTANI BIETOLE</p>	<p><b>Cod. 26330</b> RANGHINATORE FORT F2</p>
<p><b>Cod. 26340</b> RANGHINATORE FORT F3</p>	<p><b>Cod. 26350</b> RANGHINATORE HAGEDORN</p>	<p><b>Cod. 26360</b> RANGHINATORE JHC CORMICK</p>
<p><b>Cod. 26370</b> RANGHINATORE LAVERDA LUNGO</p>	<p><b>Cod. 26380</b> RANGHINATORE LAVERDA VELOX</p>	<p><b>Cod. 26390</b> RANGHINATORE LINCE SUPER</p>
<p><b>Cod. 26400</b> RANGHINATORE LINCE TA</p>	<p><b>Cod. 26410</b> RANGHINATORE OLIVI - MOLON SINGOLO</p>	<p><b>Cod. 26420</b> RANGHINATORE POTTINGER</p>

## DENTI A MOLLA PER RANGHINATORI A PETTINE

<b>Cod. 26435</b> RANGHINATORE REFORM	<b>Cod. 26440</b> RANGHINATORE REPOSSI PIEGATO O DIRITTO	<b>Cod. 26450</b> RANGHINATORE SANTINI - CBR
<b>Cod. 26460</b> RANGHINATORE SLAM DIRITTO	<b>Cod. 26425</b> RANGHINATORE PRATER	<b>Cod. 26480</b> RANGHINATORE TONUTTI VORAS

## DENTI A MOLLA PER RANGHINATORI A NASTRO

<b>Cod. 26510</b> RANGHIN. A NASTRO BITTANTE - MORELLATO	<b>Cod. 26520</b> RANGHIN. A NASTRO CECCATO	<b>Cod. 26530</b> RANGHIN. A NASTRO DA ROS
<b>Cod. 26540</b> RANGHIN. A NASTRO GASPARDO	<b>Cod. 26550</b> RANGHIN. A NASTRO MOLON MINI	<b>Cod. 26560</b> RANGHIN. A NASTRO MOLON TIPO NUOVO
<b>Cod. 26570</b> RANGHIN. A NASTRO MOLON TIPO VECCHIO	<b>Cod. 26580</b> RANGHIN. A NASTRO P Z 69	<b>Cod. 26590</b> RANGHIN. A NASTRO PONSO
<b>Cod. 26610</b> RANGHIN. A NASTRO TIGRE - SICMA	<b>Cod. 26620</b> RANGHIN. A NASTRO XOTTA CORTO	<b>Cod. 26630</b> RANGHIN. A NASTRO XOTTA LUNGO

# DENTI A MOLLA PER RANGHINATORI STELLARI

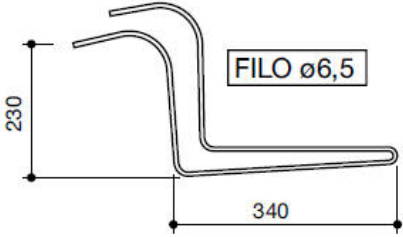
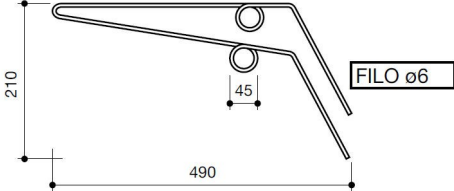
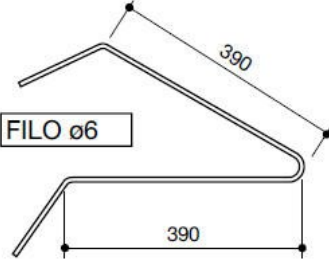
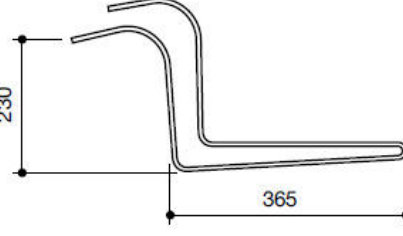
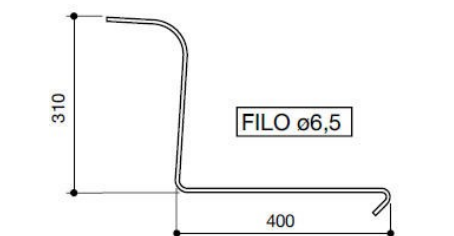
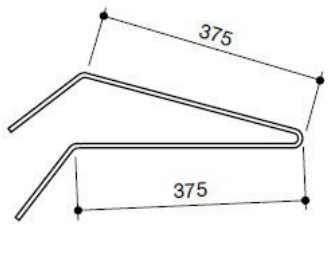
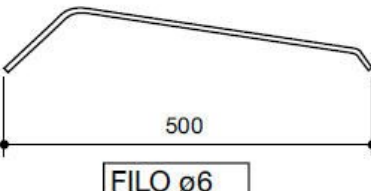
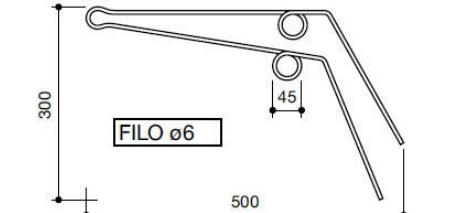
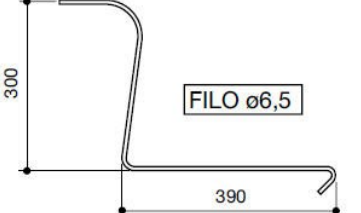
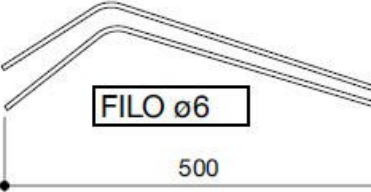
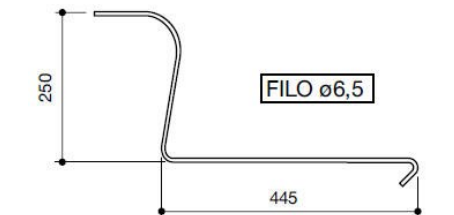
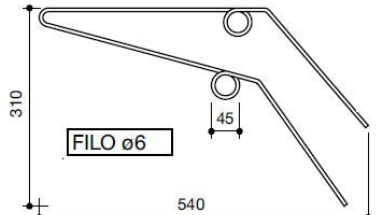
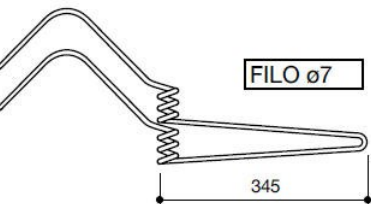
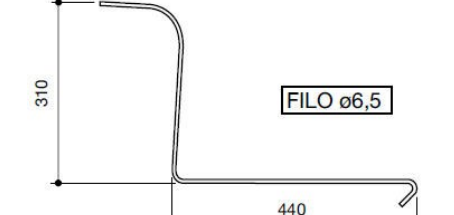
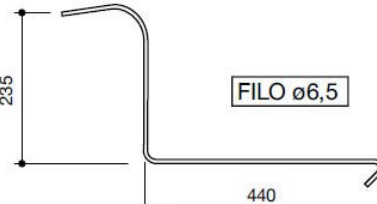









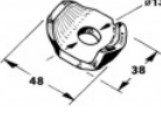

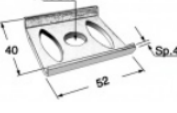

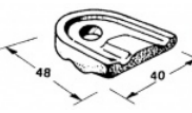



		
		
<p>Cod. 26650 RANGHIN. STELLARE BAUTZ LUNGO-CORTO</p>	<p>Cod. 26720 RANGHIN. STELLARE DA ROS</p>	<p>Cod. 26730 RANGHIN. STELLARE HEUMA INTERNO-ESTERNO</p>
		
<p>Cod. 26750 RANGHIN. STELLARE ORIONE</p>	<p>Cod. 26760 RANGHIN. STELLARE PIAVE</p>	<p>Cod. 26780 RANGHIN. STELLARE REMY JOHN DEERE</p>
		
<p>Cod. 26790 RANGHIN. STELLARE SOENERAND</p>	<p>Cod. 26795 RANGHIN. STELLARE SPRING MASTER</p>	<p>Cod. 26800 RANGHIN. STELLARE TIGRE</p>
		
<p>Cod. 26810 RANGHIN. STELLARE TONUTTI PORTATO</p>	<p>Cod. 26830 RANGHIN. STELLARE TONUTTI SINGOLO - VICON LARGO</p>	<p>Cod. 26845 RANGHIN. STELLARE VICON STRETTO</p>

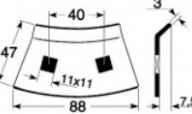
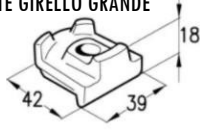
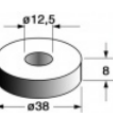

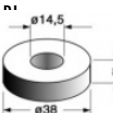
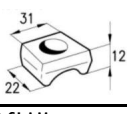
# DENTI A MOLLA PER VOLTAFIENO

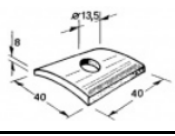

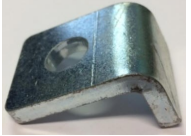
<p><b>Cod. 25560</b> VOLTAFIENO BCS</p>	<p><b>Cod. 25570</b> VOLTAFIENO CECCATO</p>	<p><b>Cod. 25580</b> VOLTAFIENO LANZ 1° TIPO</p>
<p><b>Cod. 25590</b> VOLTAFIENO LANZ 2° TIPO</p>	<p><b>Cod. 25600</b> VOLTAFIENO LAVERDA</p>	<p><b>Cod. 25605</b> VOLTAFIENO LINCE</p>
<p><b>Cod.</b> VOLTAFIENO TREBO</p>		

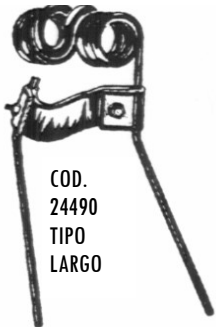

# ATTACCHI FERMADENTI - ARTICOLI VARI

Cod.	Descrizione prodotto	Cod.	Descrizione prodotto
24370	FERMADENTE AUTOCARICANTE MENGELE 	24445	FERMADENTE GIRO-ANDANATORE GALFRÈ U.T. 
24375	FERMADENTE AUTOCARICANTE KEMPER-KRONE 	24447	FERMADENTE GIRELLO MORRA (PIASTRA FORI OVALI) 
24390	FERMADENTE GIRELLO FAHR 	24450	FERMADENTE GIRO-ANDANATORE SLAM 
24400	FERMADENTE GIRELLO FAHR T. NUOVO 	24470	FERMADENTE RANGHINATORE HEUMA 
24402	FERMADENTE GIRELLO FELLA T. NUOVO 	24480	FERMADENTE GIRELLO D7 
24405	FERMADENTE GIRELLO MORRA - FAHR F. mm 10 COMPLETO 	24485	FERMADENTE RANGHINATORE VICON LELY - TONUTTI ST. 
24410	FERMADENTE GIRELLO GRANDE 	24486	RONDELLA Ø 38x12,5x8 PER G.A.ND. KUHN - FELLA 
24420	FERMADENTE GIRELLO NEW HOLLAND - GIRO-ANDANATORE STOLL 	24487	RONDELLA Ø 38x14,5x8 PER GIRELLO KUHN - V... 
24430	FERMADENTE GIRELLO PICCOLO 	24496	FERMADENTE GIRELLO KUHN COMPL. 
24440	FERMADENTE GIRELLO SLAM - FONTANESI 	24381	FERMADENTE GIRELLO POTTINGER 
24442	FERMADENTE GIRO-ANDANATORE KRONE 		(STAMPATO)
24497	FERMADENTE GA SQUADRA DA ROS 	24385	FERMADENTE GIRELLO POTTINGER 

KIT SICUREZZA PER DENTI	KIT SICUREZZA PER DENTI
	

Cod.	Descrizione prodotto	
24495	BULLONE TE 12x70 - 12x80 PER ATTACCO DENTI GIRELLO	
24496	DADO CONELOCK M12	
24498	BULLONE TTDE M 8x25 PER DENTE RANGH. BCS-8	
24499	BULLONE TTDE M 10x25 PER DENTE RANGH. BCS-10	

Cod.	Descrizione prodotto	
24505	VITE CINGHIE ROTOBALLE CON DADO 6 MB	
24506	SPEZZONE FORATO CINGHIA 120 (mm 150)	
24507	SPEZZONE FORATO CINGHIA 180 (mm 150)	
24508	COPERCHIO RIPARO CINGHIA 120 (RETE)	
24509	PIASTRINA ESTERNA CINGHIA 120 (RETE)	
24510	PIASTRINA INTERNA CINGHIA 120 (RETE)	
24511	COPERCHIO RIPARO CINGHIA 180 (RETE)	
24512	PIASTRINA ESTERNA CINGHIA 180 (RETE)	
24513	PIASTRINA INTERNA CINGHIA 180 (RETE)	

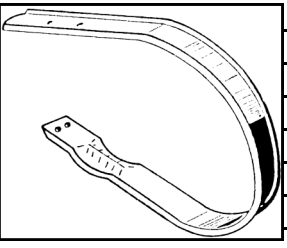

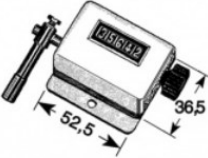

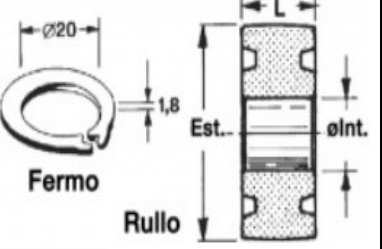
Cod.	Descrizione prodotto	
24300	FASCIA PICK-UP D.B.D.	
24310	FASCIA PICK-UP R. PR. WOLVO	
24320	FASCIA PICK-UP FORT	
24330	FASCIA PICK-UP EUROPA	
24340	FASCIA PICK-UP KEMPER	
24345	FASCIA PICK-UP CLAAS ROLLANT	
24350	FASCIA PICK-UP SAIMM STRETTA	
24360	FASCIA PICK-UP LUXOR	
24364	TUBO GUIDAMOLLA Ø 28 SP. mm 1x380	

Cod.	Descrizione prodotto	
24367	CONTABALLE TENUTA STAGNA DESTRO/SINISTRO R. ORARIA/R. ANTIORARIA	
24368	CONTABALLE NORMALE DESTRO/SINISTRO R.O	

Cod.	Descrizione prodotto	
24515	RULLINO NYLON Ø mm 60 foro mm 20	 <p>Fermo</p> <p>Rullo</p>
24516	RULLINO NYLON Ø mm 60 foro mm 25	
24517	ANELLO DI FERMO PER RULLINO	

ALTRI MODELLI DI FERMADENTI SONO FORNIBILI A RICHIESTA

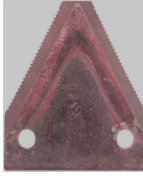
## DENTI E SEZIONI LAMA PER MIETITREBBIE



24040	DENTE MTR CLAAS DOPPIO 676235		24160	SEZIONE CLAAS RIG. SOPRA F. mm 7 6112031		24241	SEZIONE N. HOLLAND SOIA F. QUADRO 755207 (STELLA)	
24050	DENTE MTR CLAAS DOPPIO 676249 PUNTA CORTA		24180	SEZIONE CLAAS SOIA DOPPIA GB 7000 650561.0		24242	SEZIONE N. HOLLAND F. QUADRO ALLEGGERITA 84998682	
24060	PREMILAMA CLAAS SOIA STAMPATO 650597		24190	SEZIONE HESSTON RIG. SOPRA MC 333,5 - 049916 (FUX)		24243	SEZIONE N. HOLLAND F. QUADRO BUSATIS RIGATA GROSSA 755207	
24080	DENTE MTR JOHN DEERE H61954		24192	SEZIONE HESSTON RIG. SOPRA MC 333,5 049916 (STELLA)		24245	SEZIONE N. HOLLAND F. QUADRO ALLEGGERITA 84998682 <b>CROMATA</b>	
24090	DENTE MTR NEW HOLLAND 379720		24157	SEZIONE RIGATA SOPRA mm 2.7 DINLAND 300		24247	SEZIONE SCHUMACHER J. DEERE RIGATA SOPRA ALLEGGERITA (10.961)	
24100	PREMILAMA NEW HOLLAND SOIA 823269		24205	SEZIONE JOHN DEERE ALLEGGERITA H207929 H136807		24248	SEZIONE SCHUMACHER LAVERDA RIGATA SOPRA ALLEGGERITA 322702850	
24110	DENTE MTR NEW HOLLAND SOIA TIPO N. 823270		24215	SEZIONE MASSEY FERGUSON 206236-55A		24165	SEZIONE CLAAS RIGATA SOPRA F. mm 7 6112031 RASSPE	
24130	DENTE MTR NEW HOLLAND SOIA 466789		24220	SEZIONE NEW HOLLAND J. DEERE 309197		24216	SEZIONE NEW HOLLAN T. NUOVO - CLAYSON 87728905	
24131	DENTE MTR NEW HOLLAND SOIA SUPERIORE 466845		24230	SEZIONE NEW HOLLAND F. mm 5,5 365110		24240	SEZIONE N. HOLLAND SOIA F. QUADRO 755207 (FUX)	
24133	DENTE DOPPIO MTR SCHUMACHER		24240	SEZIONE N. HOLLAND SOIA F. QUADRO 755207 (FUX)				
24085	DENTE HESSTON 049270							
24150	BULLONE TTQST 6x16 - 22 - 27 DADO AUTOBLOCCANTE							
24152	BULLONE TQ 10x10 - QST 1/2 mm 2 - 6x16 ~ 6x22 ~ 6x27 (SEZIONI 755207)							
24154	BULLONE TT/CE (O TAGLIO) 5x16 - 5x32 ZIGRINATO DADO TRIBLOC							
24155	BULLONE TE 6x16 - 6x20 ZIGRINATO DADO TRIBLOC (SCHUMACHER)							

## DENTI E SEZIONI LAMA PER MIETITREBBIE

Cod.	Descrizione prodotto	
24075	DENTE MTR JOHN DEERE TRIPLO H153855	
24095	DENTE MTR NEW HOLLAND 245RS FORI mm 12	
24132	DENTE DOPPIO MTR NEW HOLLAND 80916328	
24134	DENTE TRIPLO SCHUMACHER JOHN DEERE 410400039	
24137	DENTE TRIPLO HERDER 95721016 PER <b>CESTA FALCIANTE</b>	

Cod.	Descrizione prodotto	
24236	SEZIONE N. HOLLAND SOIA TRE FORI QUADRI 755207	
24238	SEZIONE N. HOLLAND SOIA F. QUADRO 755207 CROMATA	
24255	SEZIONE HERDER PER <b>CESTA FALCIANTE</b> 95720046	
24256	SEZIONE HERDER PER <b>CESTA FALCIANTE</b> 65720047 CON PIOLO	

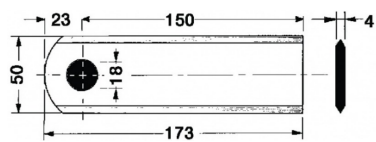
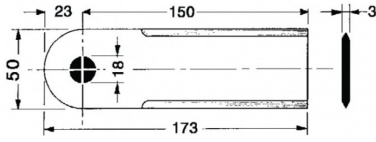
## COLTELLI TRINCIAPAGLIA

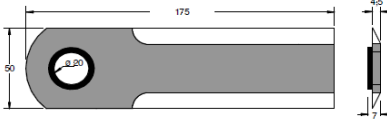
24284	COLTELLO TRINCIAPAGLIA BISO 173X50X4 FORO mm 18	
24280	COLTELLO TRINCIAPAGLIA BISO 173X50X3 FORO mm 18	
24283	COLTELLO TRINCIAPAGLIA BISO 173X50X4 FORO mm 18 SEGHETTATO	
24285	COLTELLO TRINCIAPAGLIA BISO 173X50X4,50 FORO mm 20 CON BOCCOLA	

45.599 N 11.635 E



L-M-M-G-V 08:00/12:30  
14:30/18:30  
SABATO CHIUSO



**Da Vicenza, o dal casello autostradale di Vicenza Nord (A31):**

proseguire dopo l'uscita di Vicenza Nord in direzione Treviso per circa 2 km. Imboccare sulla destra il cavalcavia che attraversa la Statale. In fondo allo stop prendere a sinistra; alla piccola rotondina proseguire dritti in direzione S. Pietro in Gu; dopo 300 m girare a sinistra (zona artigianale di Bolzano Vicentino); dopo 200 m svoltare a sinistra in Via dell'Artigianato.

**Da Treviso:**

circa 1 km dopo i "Mangimi Veronesi" (a sinistra) in vista del cavalcavia svoltare a destra in direzione S. Pietro in Gu; alla piccola rotondina proseguire dritti; dopo 300 m girare a sinistra (zona artigianale di Bolzano Vicentino); dopo 200 m svoltare a sinistra in Via dell'Artigianato.

